



Accessories for Pipelines

To
contents
click
here

24
Pricelist

How to navigate through this active PDF file

- ➔ Just click on a product group in the contents to jump directly to its page
- ➔ With a click on the product information button, you can easily access the relevant product information on our

The image shows a navigation flow from a content menu to a product page. The content menu lists various products with icons for information and back-to-contents. An orange arrow points from the 'Bolted Casing Spacers 4 pipes' entry to a product page. A green arrow points from the 'Product information' icon on the product page back to the content menu.

- ➔ Click on the text "back to contents" (on each page in lower right corner) to return to contents

Skid height 25, 36, 50 and 75 mm: max. static capacity 2000kg/ring
 Skid height 100 and 125 mm: max. static capacity 1000kg/ring

KMS-Spacers, price per segment, screws V2A, nuts V4A stainless steel

	Segments	Packing unit	Art.-No.	€/pcs.
	KMS-1 25	90	50020	9,85
	KMS-1 36	80	50021	11,25
	KMS-1 50	60	50022	12,95
	KMS-1 75	40	50023	15,95
	KMS-1 100	30	50024	19,00
	KMS-1 125	20	50025	20,55
	KMS-1,5 25	70	50030	13,80
	KMS-1,5 36	55	50031	15,80
	KMS-1,5 50	40	50032	18,15
	KMS-1,5 75	25	50033	22,25
	KMS-1,5 100	20	50034	26,55
	KMS-1,5 125	15	50035	28,75

© 4pipes GmbH 2023 11 [back to contents](#)

Content



Products	Product info	Product group	Page
 Casing Spacers 4 pipes - System raci - screwless		700	5 - 10
 Bolted Casing Spacers 4 pipes		710	11 - 12
 Casing End Seals Type AKT/AWM, AST, AKG/AKO 4 pipes		750	13 - 21
 Casing End Seals Type ASTM 4 pipes		800	22 - 25
 Heat Shrink Products and Accessories 4 pipes		500	26 - 28
 Corrosion Protection Tapes 4 pipes		600	29 - 32
 Mechanical Pipeline Protection 4 pipes Fibercoat Ultra / Rock Shield Fleece / Pipecoat Plus		650	33
 Pressio®-Rings Wall Penetration Seals 4 pipes		200	34 - 38
 Pressio®-Rings BlackLine 4 pipes		210	39
 Wall Penetration Seals 4 pipes Pressio® Individual and potable water		200	40 - 41
 Wall Penetration Seals Pressio® Universal with onion-rings technology Wall Penetration Seals Pressio® 4 cables®		200	42 - 46
 Pressio® Universal BlackLine seals with onion-rings technology		210	43
 Flexible pipe district heating baseplate penetration 4 pipes		275	47
 Pressio® Wall Penetration Seals and Wall Sleeves with fix-loose flange 4 pipes		250	48 - 50
 Pressio®-Elements Wall Penetration Seals 4 pipes		100	51 - 56
 Manhole Connectors Type P-MC 4 pipes		330	57
 Conical sealing plugs 4 pipes		410	58
 Stopaq FN 2100 Sealing System 4 pipes		225	58
 Aqua Stopper Pipeline Closure Plugs 4 pipes		375	59
 Compenseal and Sealing Sleeve Type KMR 4 pipes		850	60 - 61

Products		Product info	Product group	Page
	Wall Collars 4 pipes		300	62
	Pipe Bushings 4 pipes		415	63
	Wall Sleeve Fiber Cement 4 pipes		400	64 - 65
	Wall Sleeves / Shaft Linings PVC 4 pipes		410	66
	Epoxy Coating Resin, 1K Beto-coat, Wall Sleeves Steel 4 pipes		400/420	67
	Rubber Steel Gasket Type RSG, RSG-TW-K and RSG for ANSI Flanges 4 pipes Rubber Gasket flexible Type RFG 4 pipes Rubber Steel Gasket adjustable Type RSG-TW-V 4 pipes		425 up to DN 300 450 from DN 350 450	68 - 73
	Combi-Seal Flange Isolation Gaskets Water Type TW, Gas Type G and for Steam Type G200 4 pipes		475	74 - 77
	Flange Screw Isolation-KIT for Combi-Seal TW und G Flange Screw Isolation Accessories 4 pipes		480	78 - 79
	Cable Duct Fittings 4 pipes		890	80
	Cleaning Pigs 4 pipes		950	81
	Tools 4 pipes – Pipe Bevelling Tool, Cleaning Strap, Uni-Key-Adapter, Shore D Measuring Tool		900	82
	Magnetic Manhole Cover Hammer and Accessories 4 pipes		970	83
	Pipe Storage 4 pipes		960	84 - 86
	Terms of sales		960	87

Pricelist valid 01/2024

Minimum order value: **€ 75,00** netto
Delivery outside Germany ex works. Express Delivery: ex works

Delivery Rubber Steel Gaskets Type RSG from incl. DN 1200: ex works
Prices exclusive VAT.

Casing spacers system raci (price per segment)



Product group 700



Description		Skid height	packing unit	Art.-No.	€/pcs.
	Type I	15 mm	150	17000	4,20
	Type C	15 mm	120	17001	4,40
	Type D	15 mm	100	17002	4,70
	Type S	19 mm	100	17005	4,20
	Type T	19 mm	80	17006	4,95
	Type A	19 mm	140	17010	4,05
		36 mm	110	17011	4,45
		50 mm	80	17012	5,00
	Type B	19 mm	160	17015	3,80
		36 mm	130	17016	4,20
50 mm		90	17017	4,70	
	Type F	25 mm	150	17020	5,90
		41 mm	100	17021	6,65
		60 mm	70	17022	7,25
	Type G	25 mm	50	17025	5,80
		41 mm	60	17026	6,20
	Type M	18 mm	100	17030	9,25
		36 mm	60	17031	10,15
		50 mm	40	17032	11,25
		75 mm	30	17033	12,45
		90 mm	25	17034	14,65
	Type N	18 mm	100	17040	8,05
		36 mm	70	17041	9,25
		50 mm	50	17042	10,15
		75 mm	35	17043	11,25
		90 mm	30	17044	14,25
	Roller for Spacer M/75 max. load 300 kg/roller	Overall height 85 mm		17086	20,35
	Type L	25 mm	60	17090	13,25
		50 mm	30	17091	14,85
		75 mm	22	17092	18,45
		100 mm	18	17093	21,85
		125 mm	14	17094	22,95
		150 mm	12	17095	24,20
		175 mm	10	17096	28,40
200 mm	8	17097	29,00		

For drawings ordered by the customer we keep the option to charge an hourly fee up to 95,00 €

Casing spacers system raci (price per segment)



Product group 700

Description	Skid height	packing unit	Art.-No.	€/pcs	
	Type E	25 mm	50	17050	16,45
		41 mm	26	17051	18,30
		60 mm	18	17052	19,75
		90 mm	12	17053	26,55
		110 mm	10	17054	30,90
	Type H	130 mm	8	17055	32,95
		25 mm	60	17060	13,15
		41 mm	58	17061	14,60
		60 mm	40	17062	18,45
		90 mm	26	17063	18,60
 Roller for Spacer Type E41 max. load 2000 kg	110 mm	22	17064	20,70	
	130 mm	18	17065	21,75	
 Roller for Spacer E/90 max. load 300 kg/roller	Overall height 41 mm	-		50,00	
	Overall height 110 mm	-	17085	21,80	



OD carrier pipe in mm		Number of segments per ring		Skid height in mm												Distance recommended in metre
				25		41		60		90		110		130		
min.	max.	E	H	Art.-No.	€/ring	Art.-No.	€/ring	Art.-No.	€/ring	Art.-No.	€/ring	Art.-No.	€/ring	Art.-No.	€/ring	max. static capacity 2700 kg/ring
306*	354	3	1	17362	62,50	17402	69,50	17442	77,70	17482	98,25	17522	113,40	17562	120,60	2
355	397	4		17363	65,80	17403	73,20	17443	79,00	17483	106,20	17523	123,60	17563	131,80	2
398	457	4	1	17364	78,95	17404	87,80	17444	97,45	17484	124,80	17524	144,30	17564	153,55	2
458	489	5		17365	82,25	17405	91,50	17445	98,75	17485	132,75	17525	154,50	17565	164,75	2
490	549	5	1	17366	95,40	17406	106,10	17446	117,20	17486	151,35	17526	175,20	17566	186,50	2
550	580	6		17367	98,70	17407	109,80	17447	118,50	17487	159,30	17527	185,40	17567	197,70	2
581	641	6	1	17368	111,85	17408	124,40	17448	136,95	17488	177,90	17528	206,10	17568	219,45	2
642	732	7		17369	115,15	17409	128,10	17449	138,25	17489	185,85	17529	216,30	17569	230,65	2
733	800	8		17370	131,60	17410	146,40	17450	158,00	17490	212,40	17530	247,20	17570	263,60	1,8
801	900	9		17371	148,05	17411	164,70	17451	177,75	17491	238,95	17531	278,10	17571	296,55	1,8
901	1000	10		17372	164,50	17412	183,00	17452	197,50	17492	265,50	17532	309,00	17572	329,50	1,8
1001	1099	11		17373	180,95	17413	201,30	17453	217,25	17493	292,05	17533	339,90	17573	362,45	1,8
1100	1191	12		17374	197,40	17414	219,60	17454	237,00	17494	318,60	17534	370,80	17574	395,40	1,8
1192	1283	13		17375	213,85	17415	237,90	17455	256,75	17495	345,15	17535	401,70	17575	428,35	1,5
1284	1374	14		17376	230,30	17416	256,20	17456	276,50	17496	371,70	17536	432,60	17576	461,30	1,5
1375	1466	15		17377	246,75	17417	274,50	17457	296,25	17497	398,25	17537	463,50	17577	494,25	1,2
1467	1558	16		17378	263,20	17418	292,80	17458	316,00	17498	424,80	17538	494,40	17578	527,20	1,2
1559	1650	17		17379	279,65	17419	311,10	17459	335,75	17499	451,35	17539	525,30	17579	560,15	1,2
1651	1741	18		17380	296,10	17420	329,40	17460	355,50	17500	477,90	17540	556,20	17580	593,10	1
1742	1833	19		17381	312,55	17421	347,70	17461	375,25	17501	504,45	17541	587,10	17581	626,05	1
1834	1925	20		17382	329,00	17422	366,00	17462	395,00	17502	531,00	17542	618,00	17582	659,00	0,8
1926	2108	21		17383	345,45	17423	384,30	17463	414,75	17503	557,55	17543	648,90	17583	691,95	0,7
2109	2200	23		17384	378,35	17424	420,90	17464	454,25	17504	610,65	17544	710,70	17584	757,85	0,7
2201	2292	24		17385	394,80	17425	439,20	17465	474,00	17505	637,20	17545	741,60	17585	790,80	0,7

*M/N spacers are recommended for these sizes

For drawings ordered by the customer we keep the option to charge an hourly fee up to 95,00 €

Casing spacers system raci (price per ring)



Product group 700

Type L		Skid heights 25, 50, 75, 100, 125, 150, 175, 200 mm																Distance recommended in m	
OD carrier pipe in mm		Number of segments per ring	Skid height in mm																
min.	max.		L	25		50		75		100		125		150		175			200
			Art.-No.	€/ring	Art.-No.	€/ring	Art.-No.	€/ring	Art.-No.	€/ring	Art.-No.	€/ring	Art.-No.	€/ring	Art.-No.	€/ring	Art.-No.	€/ring	
355	397	4	17587	53,00	17602	59,40	17619	73,80	17634	87,40	17648	91,80	17663	96,80	17678	113,60	17840	116,00	2,5
450	510	5	17588	66,25	17603	74,25	17620	92,25	17635	109,25	17649	114,75	17664	121,00	17679	142,00	17841	145,00	2,5
540	610	6	17589	79,50	17604	89,10	17621	110,70	17636	131,10	17650	137,70	17665	145,20	17680	170,40	17842	174,00	2,5
625	715	7	17590	92,75	17605	103,95	17622	129,15	17637	152,95	17651	160,65	17666	169,40	17681	198,80	17843	203,00	2,5
715	805	8	17591	106,00	17606	118,80	17623	147,60	17638	174,80	17652	183,60	17667	193,60	17682	227,20	17844	232,00	2,5
805	895	9	17592	119,25	17607	133,65	17624	166,05	17639	196,65	17653	206,55	17668	217,80	17683	255,60	17845	261,00	2
895	985	10	17593	132,50	17608	148,50	17625	184,50	17640	218,50	17654	229,50	17669	242,00	17684	284,00	17846	290,00	2
985	1075	11	17594	145,75	17609	163,35	17626	202,95	17641	240,35	17655	252,45	17670	266,20	17685	312,40	17847	319,00	1,5
1075	1160	12	17595	159,00	17610	178,20	17627	221,40	17642	262,20	17656	275,40	17671	290,40	17686	340,80	17848	348,00	1
1160	1250	13	17596	172,25	17611	193,05	17628	239,85	17643	284,05	17657	298,35	17672	314,60	17687	369,20	17849	377,00	1
1250	1340	14	17597	185,50	17612	207,90	17629	258,30	17644	305,90	17658	321,30	17673	338,80	17688	397,60	17850	406,00	1
1340	1430	15	17598	198,75	17613	222,75	17630	276,75	17645	327,75	17659	344,25	17674	363,00	17689	426,00	17851	435,00	0,8
1430	1520	16	17599	212,00	17614	237,60	17631	295,20	17646	349,60	17660	367,20	17675	387,20	17690	454,40	17852	464,00	0,8
1520	1610	17	17600	225,25	17615	252,45	17632	313,65	17647	371,45	17661	390,15	17676	411,40	17691	482,80	17853	493,00	0,5
1610	1750	18	17601	238,50	17616	267,30	17633	332,10	17618	393,30	17662	413,10	17677	435,60	17692	511,20	17854	522,00	0,5

Skid height 25 and 50 mm: max. static capacity 3000 kg/ring
 Skid height 75 and 100 mm: max. static capacity 2500 kg/ring

Skid height 125 and 150 mm: max. static capacity 2000 kg/ring
 Skid height 175 and 200 mm: max. static capacity 1500 kg/ring



Type M/N		Skid heights 18, 36, 50, 75, 90 mm												Distance recommended in m
OD carrier pipe in mm		Number of segments per ring		Skid height in mm										
min.	max.	M	N	18		36		50		75		90		
				Art.-No.	€/ring	Art.-No.	€/ring	Art.-No.	€/ring	Art.-No.	€/ring	Art.-No.	€/ring	
160*	201	2		17260	18,50	17280	20,30	17300	22,50	17320	24,90	17340	29,30	2
202	227	1	2	17261	25,35	17281	28,65	17301	31,55	17321	34,95	17341	43,15	2
228	252	2	1	17262	26,55	17282	29,55	17302	32,65	17322	36,15	17342	43,55	2
253	286	3		17263	27,75	17283	30,45	17303	33,75	17323	37,35	17343	43,95	2
287	311	2	2	17264	34,60	17284	38,80	17304	42,80	17324	47,40	17344	57,80	2
312	337	3	1	17265	35,80	17285	39,70	17305	43,90	17325	48,60	17345	58,20	2
338	395	4		17266	37,00	17286	40,60	17306	45,00	17326	49,80	17346	58,60	2
396	421	4	1	17267	45,05	17287	49,85	17307	55,15	17327	61,05	17347	72,85	2
422	505	5		17268	46,25	17288	50,75	17308	56,25	17328	62,25	17348	73,25	2
506	590	6		17269	55,50	17289	60,90	17309	67,50	17329	74,70	17349	87,90	1,5
591	674	7		17270	64,75	17290	71,05	17310	78,75	17330	87,15	17350	102,55	1,5
675	759	8		17271	74,00	17291	81,20	17311	90,00	17331	99,60	17351	117,20	1,5

*F/G spacers are recommended for these sizes

For drawings ordered by the customer we keep the option to charge an hourly fee up to 95,00 €

Casing spacers system raci (price per ring)



Product group 700

 <p>Casing spacers Type A/B No special tool necessary!</p>	Type A/B		Skid heights 19, 36, 50 mm								
	OD carrier pipe in mm		Number of segments per ring		Skid height in mm						Distance recommended in metre
	min.	max.	A	B	19		36		50		max. static capacity 180 kg/ring
					Art.-No.	€/ring	Art.-No.	€/ring	Art.-No.	€/ring	
55,4	65,6*		2	17140	7,60	17170	8,40	17185	9,40	1,5	
61,3	71,5*	1	1	17141	7,85	17171	8,65	17186	9,70	1,5	
67,3	77,4*	2		17142	8,10	17172	8,90	17187	10,00	1,5	
82,9	94,4		3	17143	11,40	17173	12,60	17188	14,10	1,5	
89,1	104,3	1	2	17144	11,65	17174	12,85	17189	14,40	1,5	
101,1	116	3		17145	12,15	17175	13,35	17190	15,00	1,5	
110,8	131,2		4	17146	15,20	17176	16,80	17191	18,80	1,5	
116,6	137,1	1	3	17147	15,45	17177	17,05	17192	19,10	1,5	
134,7	154,8	4		17148	16,20	17178	17,80	17193	20,00	1,5	
150,3	175,8	2	3	17149	19,50	17179	21,50	17194	24,10	1,5	
168,5	193,5	5		17150	20,25	17180	22,25	17195	25,00	1,5	
193,5**	229,6**		7	17151	26,60	17181	29,40	17196	32,90	1	
202,2**	232,2**	6		17152	24,30	17182	26,70	17197	30,00	1	
230**	254**	6	1	17153	28,10	17183	30,90	17198	34,70	1	
255**	279**	7		17155	28,35	17138	31,15	17139	35,00	1	
280**	309,6**	8		17154	32,40	17184	35,60	17199	40,00	1	

* S/T spacers are recommended for these sizes **M/N spacers are recommended for these sizes

	Type F/G		Skid heights 25, 41, 60 mm								
	OD carrier pipe in mm		Number of segments per ring		Skid height in mm						Distance recommended in metre
	min.	max.	F	G	25		41		60		max. static capacity 500 kg/ring
					Art.-No.	€/ring	Art.-No.	€/ring	Art.-No.	€/ring	
116*	145*	2		17200	11,80	17220	13,30	17240	14,50	2	
124*	150*	1	2	17201	17,50	17221	19,05	17241	20,15	2	
154	182	2	1	17202	17,60	17222	19,50	17242	20,95	2	
189	217	3		17203	17,70	17223	19,95	17243	21,75	2	
219	256	3	1	17204	23,50	17224	26,15	17244	28,20	1,5	
254	282	4		17205	23,60	17225	26,60	17245	29,00	1,5	
283	315	4	1	17206	29,40	17226	32,80	17246	35,45	1,5	
316	345	5		17207	29,50	17227	33,25	17247	36,25	1,5	

*S/T or A/B spacers are recommended for these sizes

For drawings ordered by the customer we keep the option to charge an hourly fee up to 95,00 €

Casing spacers system raci (price per ring)





Product group 700

 <p>Casing spacers Type S/T No special tool necessary!</p>	Type S/T		Skid height 19 mm					
	OD carrier pipe in mm		Number of segments per ring			Skid height in mm		Distance recommended in metre
	min.	max.	S	T	19		max. static capacity 110 kg/ring	
					Art.-No.	€/ring		
		59	68	2		17120	8,40	1,5
		69	75	1	1	17121	9,15	1,5
		76	84		2	17122	9,90	1,5
		88	102	3		17123	12,60	1,5
		103	107	2	1	17124	13,35	1,5
		108	114	1	2	17125	14,10	1,5
		115	120		3	17126	14,85	1,5
		121	132	4		17127	16,80	1,5
		133	140	3	1	17128	17,55	1,5
	141	146	2	2	17129	18,30	1,5	
	147	152	1	3	17130	19,05	1,5	
	153	168		4	17131	19,80	1,5	

 <p>Casing spacers Type I/C/D No special tool necessary!</p>	Type I/C/D		Skid height 15 mm						
	OD carrier pipe in mm		Number of segments per ring			Skid height in mm		Distance recommended in metre	
	min.	max.	I	C	D	15		max. static capacity 200 kg/ring	
						Art.-No.	€/ring		
		42	52	1			17100	4,20	1
		58	79		1		17101	4,40	1
		80	93			1	17102	4,70	1
		94	100	2			17103	8,40	1
		101	120	1	1		17104	8,60	1
		121	145		2		17105	8,80	1
	146	165		1	1	17106	9,10	1	
	166	197			2	17107	9,40	1	

For drawings ordered by the customer we reserve the right to charge an hourly fee up to 95,00 €

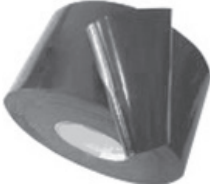

	Description	Art.-Nr.	€/pcs.
 <p>Fastening clamp F/G</p>	<p>Fastening clamp for Type F/G</p>	<p>17076</p>	<p>119,10*</p>
 <p>Fastening clamp M/N, F/G, L</p>	<p>Fastening clamp for Type M/N, F/G and L Skid height up to 90 mm</p> <p>Fastening clamp for Type M/N and L Skid height up to 200 mm</p>	<p>17070</p> <p>17077</p>	<p>553,25*</p> <p>728,30*</p>
 <p>Fastening clamp E/H 130</p>	<p>Fastening clamp for Typ E/H</p> <p>Rent Fastening clamp M/N. E/H: 10% per month</p>	<p>17072</p>	<p>738,10*</p>
	<p>Anti-slide tape against slipping spacers on smooth pipe surfaces. Width 50 mm. Roll per 15 m length</p>	<p>17080</p>	<p>28,85</p>
	<p>Anti-slide tape against slipping spacers on smooth pipe surfaces. Width 100 mm. Roll per 15 m length</p>	<p>17081</p>	<p>57,50</p>

***Fastening clamps not discountable**

Bolted casing spacers 4 pipes



Product group 710



Casing spacers Type KMS-1 and KMS-1,5
incl. screws and nuts



Distance recommended in m

Pipesize		Pipe OD in mm		Number of segments		Skid height in mm										Screws		Distance recommended in m	
DN	inch	min.	max.	KMS-1	KMS-1,5	25		36		50		75		100		125			quantity/size
						Art.-No.	€/ring	Art.-No.	€/ring	Art.-No.	€/ring	Art.-No.	€/ring	Art.-No.	€/ring	Art.-No.	€/ring		
400	16	400	430	4		51100	39,40	51130	45,00	51160	51,80	51190	63,80	51220	76,00	51250	82,20	8 M8 x 70	2
450	18	450	480	3	1	51101	43,35	51131	49,55	51161	57,00	51191	70,10	51221	83,55	51251	90,40	8 M8 x 70	2
500	20	500	538	5		51102	49,25	51132	56,25	51162	64,75	51192	79,75	51222	95,00	51252	102,75	10 M8 x 70	2
550	22	550	585	4	1	51103	53,20	51133	60,80	51163	69,95	51193	86,05	51223	102,55	51253	110,95	10 M8 x 70	2
600	24	600	628		4	51104	55,20	51134	63,20	51164	72,60	51194	89,00	51224	106,20	51254	115,00	8 M8 x 70	2
		629	649	6		51105	59,10	51135	67,50	51165	77,70	51195	95,70	51225	114,00	51255	123,30	12 M8 x 70	2
650	26	650	680	2	3	51106	61,10	51136	69,90	51166	80,35	51196	98,65	51226	117,65	51256	127,35	10 M8 x 70	2
		680	699	5	1	51107	63,05	51137	72,05	51167	82,90	51197	102,00	51227	121,55	51257	131,50	12 M8 x 70	2
700	28	700	732	1	4	51108	65,05	51138	74,45	51168	85,55	51198	104,95	51228	125,20	51258	135,55	10 M8 x 70	2
		732	750	7		51109	68,95	51139	78,75	51169	90,65	51199	111,65	51229	133,00	51259	143,85	14 M8 x 70	2
750	30	751	780		5	51110	69,00	51140	79,00	51170	90,75	51200	111,25	51230	132,75	51260	143,75	10 M8 x 70	2
		780	799	6	1	51111	72,90	51141	83,30	51171	95,85	51201	117,95	51231	140,55	51261	152,05	14 M8 x 70	2
800	32	800	835	2	4	51112	74,90	51142	85,70	51172	98,50	51202	120,90	51232	144,20	51262	156,10	12 M8 x 70	2
		835	850	8		51113	78,80	51143	90,00	51173	103,60	51203	127,60	51233	152,00	51263	164,40	16 M8 x 70	1,8
850	34	851	880	1	5	51114	78,85	51144	90,25	51174	103,70	51204	127,20	51234	151,75	51264	164,30	12 M8 x 70	1,8
		880	900	7	1	51115	82,75	51145	94,55	51175	108,80	51205	133,90	51235	159,55	51265	172,60	16 M8 x 70	1,8
900	36	901	951		6	51116	82,80	51146	94,80	51176	108,90	51206	133,50	51236	159,30	51266	172,50	12 M8 x 70	1,8
950	38	952	1000	2	5	51117	88,70	51147	101,50	51177	116,65	51207	143,15	51237	170,75	51267	184,85	14 M8 x 70	1,8
1000	40	1001	1050	1	6	51118	92,65	51148	106,05	51178	121,85	51208	149,45	51238	178,30	51268	193,05	14 M8 x 70	1,5
1050	42	1051	1100		7	51119	96,60	51149	110,60	51179	127,05	51209	155,75	51239	185,85	51269	201,25	14 M8 x 70	1,5
1100	44	1101	1150	2	6	51120	102,50	51150	117,30	51180	134,80	51210	165,40	51240	197,30	51270	213,60	16 M8 x 70	1,5
1150	46	1151	1200	1	7	51121	106,45	51151	121,85	51181	140,00	51211	171,70	51241	204,85	51271	221,80	16 M8 x 70	1,5
1200	48	1201	1249		8	51122	110,40	51152	126,40	51182	145,20	51212	178,00	51242	212,40	51272	230,00	16 M8 x 70	1,5

Skid height 25, 36, 50 and 75 mm: max. static capacity 2000kg/ring

Skid height 100 and 125 mm: max. static capacity 1000kg/ring

KMS-Spacers, price per segment, screws V2A, nuts V4A stainless steel

Image	Segments	Packing unit	Art.-No.	€/pcs.
		KMS-1 25	90	50020
KMS-1 36		80	50021	11,25
KMS-1 50		60	50022	12,95
KMS-1 75		40	50023	15,95
KMS-1 100		30	50024	19,00
KMS-1 125		20	50025	20,55
	KMS-1,5 25	70	50030	13,80
	KMS-1,5 36	55	50031	15,80
	KMS-1,5 50	40	50032	18,15
	KMS-1,5 75	25	50033	22,25
	KMS-1,5 100	20	50034	26,55
	KMS-1,5 125	15	50035	28,75

Bolted casing spacers 4 pipes





Product group 710

Pipe OD in mm		Number of segments		Skid height in mm												Screws	Distance recommended in m
min.	max.	KAS-1	KAS-2	20		36		50		75		90		110		quantity/ size	
				Art.-No.	€/ring	Art.-No.	€/ring	Art.-No.	€/ring	Art.-No.	€/ring	Art.-No.	€/ring	Art.-No.	€/ring		
98	130	3		51000	18,00	51010	19,50	51020	22,65	51030	25,95	51040	30,15	51050	33,75	6 M6 x 70	2
130	172	4		51001	24,00	51011	26,00	51021	30,20	51031	34,60	51041	40,20	51051	45,00	8 M6 x 70	2
173	210	5		51002	30,00	51012	32,50	51022	37,75	51032	43,25	51042	50,25	51052	56,25	10 M6 x 70	2
211	228		3	51003	24,15	51013	28,05	51023	29,55	51033	36,00	51043	47,40	51053	54,75	6 M6 x 70	2
229	260	1	3	51004	30,15	51014	34,55	51024	37,10	51034	44,65	51044	57,45	51054	66,00	8 M6 x 70	2
261	300		4	51005	32,20	51015	37,40	51025	39,40	51035	48,00	51045	63,20	51055	73,00	8 M6 x 70	1,5
301	345	1	4	51006	38,20	51016	43,90	51026	46,95	51036	56,65	51046	73,25	51056	84,25	10 M6 x 70	1,5
346	380		5	51007	40,25	51017	46,75	51027	49,25	51037	60,00	51047	79,00	51057	91,25	10 M6 x 70	1,5

Skid height 20, 36 and 50 mm: max. static capacity 750 kg/ring

Skid height 75, 90 and 110 mm: max. static capacity 500 kg/ring

KAS-Spacers, price per segment, screws V2A, nuts V4A stainless steel

	Segments	Packing unit	Art.-No.	€/pcs.
	KAS-1 20	250	50000	6,00
	KAS-1 36	130	50001	6,50
	KAS 1 50	100	50002	7,55
	KAS-1 75	65	50003	8,65
	KAS-1 90	55	50004	10,05
	KAS-1 110	35	50005	11,25
	KAS-2 20	130	50010	8,05
	KAS-2 36	80	50011	9,35
	KAS-2 50	60	50012	9,85
	KAS-2 75	35	50013	12,00
	KAS-2 90	30	50014	15,80
	KAS-2 110	25	50015	18,25

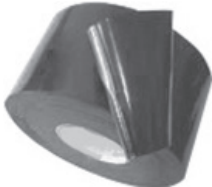
Description	Art.-No.	€/pcs.
 Anti-slide tape against slipping spacers on smooth pipe surfaces. Width 50 mm. Roll per 15 m length	17080	28,85



Casing endseals type AST, AKT, AWM



Product group 750

	Dimensions in mm	Pipe OD	Art.-No.	€/pcs.
	Endseal Type AHA 32 mm x 50 mm	25 x 40	18040	18,85

	Dimensions in mm	Pipe OD	Material	Art.-No.	€/pcs.
	Stepseal AST 20 - 90	20/30/40/50/ 75/90	EPDM	18086	21,40
	Stepseal AST 25 - 110	25/32/40/50/ 63/75/90/110	EPDM	18088	25,05
	Stepseal AST 63 - 160	63/75/90/110 125/140/160	EPDM	18089	28,15
	Stepseal AST 25 - 125	25/32/40/50/63 75/90/110/125	NBR	18087	25,05

	Dimensions in mm casing1/casing2 - min. OD carrier pipe	Pipe OD	Art.-No.	€/pcs.
 Example AKT Endseal	AKT 135/110-0	125/100-0	18090	34,60
	AKT 215/165-0	200/150-0	18091	38,75
	AWM 320/270-63	300/250-50	18092	54,00
 Example AWM Endseal	AWM 402/350-80	400/350-80	18093	75,15
	AWM 495/445-80	500/450-80	18096	91,40
	AWM 610/508-160	600/500-150	18094	123,75
	AWM 810/710-273	800/700-250	18095	178,65

Price incl. tightening straps

Casing endseals type AKG/AKO



Product group 750

Type AKG = closed Version

Type AKO = split Version

DN1 mm	X	DN2 mm	Cutting size in mm			L	Art.-No.	€/pcs.	
			Ø1	Ø2					
25	x	40	32	x	53	x	220	18200	42,45
25	x	50	32	x	66	x	220	18201	42,50
25	x	65	32	x	84	x	240	18202	42,60
25	x	80	32	x	98	x	250	18203	47,65
25	x	100	32	x	126	x	270	18204	53,75
25	x	125	32	x	154	x	290	18205	54,45
25	x	150	32	x	185	x	310	18206	56,95
25	x	200	32	x	241	x	350	18207	91,75
40	x	50	46	x	66	x	210	18210	41,30
40	x	65	46	x	84	x	230	18211	52,50
40	x	80	46	x	98	x	240	18212	53,00
40	x	100	46	x	126	x	260	18213	53,65
40	x	125	46	x	154	x	280	18214	56,35
40	x	150	46	x	185	x	300	18215	60,55
40	x	200	46	x	241	x	340	18216	66,85
50	x	65	57	x	84	x	220	18220	47,80
50	x	80	57	x	98	x	230	18221	48,45
50	x	100	57	x	126	x	250	18222	48,55
50	x	125	57	x	154	x	270	18223	48,95
50	x	150	57	x	185	x	290	18224	50,60
50	x	200	57	x	241	x	330	18225	56,20
50	x	250	57	x	300	x	370	18226	77,90
50	x	300	57	x	356	x	410	18227	121,90
50	x	350	57	x	391	x	430	18228	134,35
50	x	400	57	x	447	x	470	18229	150,85
65	x	80	72	x	98	x	220	18240	47,20
65	x	100	72	x	126	x	240	18241	47,85
65	x	125	72	x	154	x	260	18242	48,55
65	x	150	72	x	185	x	280	18243	50,20
65	x	200	72	x	241	x	320	18244	55,75
65	x	250	72	x	300	x	360	18245	77,05
65	x	300	72	x	356	x	400	18246	120,95
65	x	350	72	x	391	x	420	18247	133,15
65	x	400	72	x	447	x	460	18248	149,50

- Please inform us about exact pipe dimensions
- Please specify the endseal closed (AKG) or split (AKO)
- Prices incl. stainless steel straps, rubber CR
- Special sizes, Nitrile or Silikone rubber on request

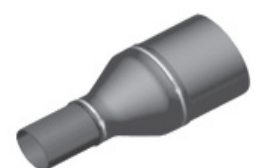

Casing endseals type AKG/AKO



Product group 750

Type AKG = closed Version

Type AKO = split Version

DN1 mm	X	DN2 mm	Cutting size in mm					Art.-No.	€/pcs.
			Ø1		Ø2		L		
80	x	100	84	x	126	x	230	18260	48,05
80	x	125	84	x	154	x	250	18261	49,45
80	x	150	84	x	185	x	270	18262	50,55
80	x	200	84	x	241	x	310	18263	57,25
80	x	250	84	x	300	x	350	18264	77,25
80	x	300	84	x	356	x	390	18265	125,25
80	x	350	84	x	391	x	420	18266	133,70
80	x	400	84	x	447	x	450	18267	149,60
80	x	450	84	x	503	x	490	18268	156,90
80	x	500	84	x	559	x	530	18269	174,10
80	x	550	84	x	615	x	570	18270	205,80
80	x	600	84	x	671	x	610	18271	253,55
80	x	650	84	x	726	x	650	18272	265,35
100	x	125	109	x	154	x	230	18280	49,45
100	x	150	109	x	185	x	250	18281	50,95
100	x	200	109	x	241	x	290	18282	57,70
100	x	250	109	x	300	x	330	18283	77,90
100	x	300	109	x	356	x	370	18284	125,70
100	x	350	109	x	391	x	400	18285	135,75
100	x	400	109	x	447	x	440	18286	150,65
100	x	450	109	x	503	x	480	18287	157,85
100	x	500	109	x	559	x	520	18288	174,80
100	x	550	109	x	615	x	550	18289	206,80
100	x	600	109	x	671	x	600	18290	254,75
100	x	650	109	x	726	x	630	18291	271,80
125	x	150	133	x	185	x	240	18300	50,80
125	x	200	133	x	241	x	280	18301	57,35
125	x	250	133	x	300	x	320	18302	77,55
125	x	300	133	x	356	x	360	18303	125,35
125	x	350	133	x	391	x	380	18304	134,80
125	x	400	133	x	447	x	420	18305	149,50
125	x	450	133	x	503	x	460	18306	156,75
125	x	500	133	x	559	x	500	18307	173,95
125	x	550	133	x	615	x	540	18308	205,55
125	x	600	133	x	671	x	580	18309	213,90
125	x	650	133	x	726	x	620	18310	231,10

- Please inform us about exact pipe dimensions
- Please specify the endseal closed (AKG) or split (AKO)
- Prices incl. stainless steel straps, rubber CR
- Special sizes, Nitrile or Silikone rubber on request



Casing endseals type AKG/AKO



Product group 750

Type AKG = closed Version

Type AKO = split Version

DN1 mm	X	DN2 mm	Cutting size in mm			Art.-No.	€/pcs.		
			Ø1	Ø2	L				
150	x	200	160	x	241	x	260	18320	65,20
150	x	250	160	x	300	x	300	18321	68,75
150	x	300	160	x	356	x	340	18322	83,40
150	x	350	160	x	391	x	360	18323	127,55
150	x	400	160	x	447	x	400	18324	156,70
150	x	450	160	x	503	x	440	18325	160,65
150	x	500	160	x	559	x	480	18326	169,20
150	x	550	160	x	615	x	520	18327	211,95
150	x	600	160	x	671	x	560	18328	218,05
150	x	650	160	x	726	x	600	18329	225,95
150	x	700	160	x	782	x	640	18330	255,25
200	x	250	208	x	300	x	270	18340	81,50
200	x	300	208	x	356	x	300	18341	84,10
200	x	350	208	x	391	x	330	18342	111,05
200	x	400	208	x	447	x	370	18343	133,20
200	x	450	208	x	503	x	410	18344	163,95
200	x	500	208	x	559	x	450	18345	168,50
200	x	550	208	x	615	x	490	18346	181,15
200	x	600	208	x	671	x	520	18347	219,20
200	x	650	208	x	726	x	560	18348	230,30
200	x	700	208	x	782	x	600	18349	241,50
200	x	750	208	x	838	x	640	18350	258,55
200	x	800	208	x	894	x	680	18351	272,05
250	x	300	259	x	356	x	270	18360	96,55
250	x	350	259	x	391	x	290	18361	101,45
250	x	400	259	x	447	x	330	18362	112,30
250	x	450	259	x	503	x	370	18363	154,90
250	x	500	259	x	559	x	410	18364	170,70
250	x	550	259	x	615	x	450	18365	184,15
250	x	600	259	x	671	x	490	18366	203,65
250	x	650	259	x	726	x	530	18367	230,45
250	x	700	259	x	782	x	570	18368	241,45
250	x	750	259	x	838	x	610	18369	258,45
250	x	800	259	x	794	x	640	18370	286,40
250	x	850	259	x	950	x	680	18371	291,40
250	x	900	259	x	1005	x	720	18372	297,55

- Please inform us about exact pipe dimensions
- Please specify the endseal closed (AKG) or split (AKO)
- Prices incl. stainless steel straps, rubber CR
- Special sizes, Nitrile or Silikone rubber on request

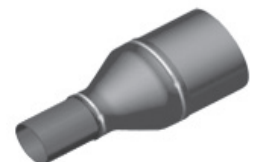

Casing endseals type AKG/AKO



Product group 750

Type AKG = closed Version

Type AKO = split Version

DN1 mm	X	DN2 mm	Cutting size in mm				Länge	Art.-No.	€/pcs.
			Ø1		Ø2				
300	x	350	308	x	391	x	260	18380	115,45
300	x	400	308	x	447	x	280	18381	133,85
300	x	450	308	x	503	x	340	18382	149,60
300	x	500	308	x	559	x	380	18383	175,20
300	x	550	308	x	615	x	420	18384	188,70
300	x	600	308	x	671	x	450	18385	209,65
300	x	650	308	x	726	x	490	18386	223,25
300	x	700	308	x	782	x	530	18387	245,10
300	x	750	308	x	838	x	570	18388	260,80
300	x	800	308	x	894	x	610	18389	274,35
300	x	850	308	x	950	x	650	18390	295,15
300	x	900	308	x	1005	x	690	18391	301,25
300	x	950	308	x	1062	x	730	18392	321,70
300	x	1000	308	x	1118	x	770	18393	367,35
350	x	400	338	x	447	x	280	18400	119,60
350	x	450	338	x	503	x	320	18401	150,35
350	x	500	338	x	559	x	360	18402	160,25
350	x	550	338	x	615	x	390	18403	182,30
350	x	600	338	x	671	x	430	18404	214,45
350	x	650	338	x	726	x	470	18405	227,75
350	x	700	338	x	782	x	510	18406	236,50
350	x	750	338	x	838	x	550	18407	266,10
350	x	800	338	x	894	x	590	18408	274,70
350	x	850	338	x	950	x	630	18409	284,25
350	x	900	338	x	1005	x	670	18410	309,10
350	x	950	338	x	1062	x	710	18411	322,05
350	x	1000	338	x	1118	x	750	18412	347,10
400	x	450	386	x	503	x	280	18420	150,05
400	x	500	386	x	559	x	320	18421	153,05
400	x	550	386	x	615	x	360	18422	199,90
400	x	600	386	x	671	x	400	18423	212,95
400	x	650	386	x	726	x	440	18424	230,45
400	x	700	386	x	782	x	480	18425	235,35
400	x	750	386	x	838	x	520	18426	242,65
400	x	800	386	x	894	x	560	18427	260,80
400	x	850	386	x	950	x	600	18428	273,10
400	x	900	386	x	1005	x	630	18429	278,10
400	x	950	386	x	1062	x	670	18430	313,25
400	x	1000	386	x	1118	x	710	18431	355,90

- Please inform us about exact pipe dimensions
- Please specify the endseal closed (AKG) or split (AKO)
- Prices incl. stainless steel straps, rubber CR
- Special sizes, Nitrile or Silikone rubber on request



Casing endseals type AKG/AKO



Product group 750

Type AKG = closed Version

Type AKO = split Version

DN1 mm	X	DN2 mm	Cutting size in mm			L	Art.-No.	€/pcs.	
			Ø1	Ø2					
450	x	500	434	x	559	x	290	18440	158,25
450	x	550	434	x	615	x	330	18441	164,85
450	x	600	434	x	671	x	370	18442	182,10
450	x	650	434	x	726	x	400	18443	210,40
450	x	700	434	x	782	x	440	18444	241,45
450	x	750	434	x	838	x	480	18445	243,85
450	x	800	434	x	894	x	520	18446	250,60
450	x	850	434	x	950	x	560	18447	279,25
450	x	900	434	x	1005	x	600	18448	290,40
450	x	950	434	x	1062	x	640	18449	297,60
450	x	1000	434	x	1118	x	680	18450	362,55
500	x	550	483	x	615	x	290	18460	169,60
500	x	600	483	x	671	x	330	18461	178,10
500	x	650	483	x	726	x	370	18462	194,10
500	x	700	483	x	782	x	410	18463	216,90
500	x	750	483	x	838	x	450	18464	252,40
500	x	800	483	x	894	x	490	18465	254,75
500	x	850	483	x	950	x	530	18466	259,80
500	x	900	483	x	1005	x	570	18467	298,95
500	x	950	483	x	1062	x	610	18468	304,10
500	x	1000	483	x	1118	x	650	18469	326,90
550	x	600	531	x	671	x	300	18480	181,15
550	x	650	531	x	726	x	340	18481	186,00
550	x	700	531	x	782	x	380	18482	197,25
550	x	750	531	x	838	x	420	18483	222,00
550	x	800	531	x	894	x	450	18484	256,70
550	x	850	531	x	950	x	490	18485	262,10
550	x	900	531	x	1005	x	530	18486	268,35
550	x	950	531	x	1062	x	570	18487	311,80
550	x	1000	531	x	1118	x	610	18488	327,90
550	x	1050	531	x	1174	x	650	18489	335,20
550	x	1100	531	x	1230	x	690	18490	412,05
600	x	650	580	x	726	x	300	18500	189,45
600	x	700	580	x	782	x	340	18501	196,15
600	x	750	580	x	838	x	380	18502	207,60
600	x	800	580	x	894	x	420	18503	236,50
600	x	850	580	x	950	x	460	18504	269,50
600	x	900	580	x	1005	x	500	18505	276,90
600	x	950	580	x	1062	x	540	18506	281,85
600	x	1000	580	x	1118	x	580	18507	298,55
600	x	1050	580	x	1174	x	620	18508	349,05
600	x	1100	580	x	1230	x	660	18509	391,90

- Please inform us about exact pipe dimensions
- Please specify the endseal closed (AKG) or split (AKO)
- Prices incl. stainless steel straps, rubber CR
- Special sizes, Nitrile or Silikone rubber on request

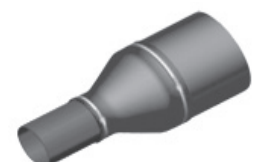

Casing endseals type AKG/AKO



Product group 750

Type AKG = closed Version

Type AKO = split Version

DN1 mm	X	DN2 mm	Cutting size in mm					Art.-No.	€/pcs.
			Ø1		Ø2		L		
650	x	700	627	x	782	x	310	18520	204,50
650	x	750	627	x	838	x	350	18521	209,45
650	x	800	627	x	894	x	390	18522	220,30
650	x	850	627	x	950	x	430	18523	261,05
650	x	900	627	x	1005	x	470	18524	285,00
650	x	950	627	x	1062	x	500	18525	294,25
650	x	1000	627	x	1118	x	540	18526	306,55
650	x	1050	627	x	1174	x	580	18527	363,20
650	x	1100	627	x	1230	x	620	18528	406,05
700	x	750	675	x	838	x	310	18540	213,30
700	x	800	675	x	894	x	350	18541	224,15
700	x	850	675	x	950	x	390	18542	230,85
700	x	900	675	x	1005	x	430	18543	270,75
700	x	950	675	x	1062	x	470	18544	294,00
700	x	1000	675	x	1118	x	510	18545	303,80
700	x	1050	675	x	1174	x	550	18546	325,70
700	x	1100	675	x	1230	x	590	18547	415,15
700	x	1150	675	x	1285	x	630	18548	426,20
700	x	1200	675	x	1342	x	670	18549	438,45
750	x	800	724	x	894	x	320	18560	236,55
750	x	850	724	x	950	x	360	18561	247,45
750	x	900	724	x	1005	x	400	18562	258,45
750	x	950	724	x	1062	x	440	18563	314,50
750	x	1000	724	x	1118	x	480	18564	337,50
750	x	1050	724	x	1174	x	520	18565	347,90
750	x	1100	724	x	1230	x	550	18566	358,90
750	x	1150	724	x	1285	x	590	18567	436,10
750	x	1200	724	x	1342	x	630	18568	447,10
750	x	1300	724	x	1453	x	710	18569	458,25
750	x	1400	724	x	1562	x	790	18570	525,50
800	x	850	772	x	950	x	330	18580	253,55
800	x	900	772	x	1005	x	360	18581	262,20
800	x	950	772	x	1062	x	400	18582	273,70
800	x	1000	772	x	1118	x	440	18583	329,45
800	x	1050	772	x	1174	x	480	18584	374,15
800	x	1100	772	x	1230	x	520	18585	384,60
800	x	1150	772	x	1285	x	560	18586	407,30
800	x	1200	772	x	1342	x	600	18587	473,95
800	x	1300	772	x	1453	x	680	18588	486,10
800	x	1400	772	x	1562	x	750	18589	497,10

- Please inform us about exact pipe dimensions
- Please specify the endseal closed (AKG) or split (AKO)
- Prices incl. stainless steel straps, rubber CR
- Special sizes, Nitrile or Silikone rubber on request



Casing endseals type AKG/AKO



Product group 750

Type AKG = closed Version

Type AKO = split Version

DN1 mm	X	DN2 mm	Cutting size in mm			L	Art.-No.	€/pcs.	
			Ø1	Ø2					
850	x	900	821	x	1005	x	330	18600	266,10
850	x	950	821	x	1062	x	370	18601	275,70
850	x	1000	821	x	1118	x	410	18602	298,00
850	x	1050	821	x	1174	x	450	18603	354,35
850	x	1100	821	x	1230	x	490	18604	402,40
850	x	1150	821	x	1285	x	530	18605	425,85
850	x	1200	821	x	1342	x	570	18606	443,05
850	x	1300	821	x	1453	x	640	18607	499,55
850	x	1400	821	x	1562	x	720	18608	511,85
900	x	950	868	x	1062	x	340	18620	274,90
900	x	1000	868	x	1118	x	380	18621	284,10
900	x	1050	868	x	1174	x	410	18622	307,30
900	x	1100	868	x	1230	x	450	18623	372,90
900	x	1150	868	x	1285	x	490	18624	425,40
900	x	1200	868	x	1342	x	530	18625	438,60
900	x	1300	868	x	1453	x	610	18626	516,55
900	x	1400	868	x	1562	x	690	18627	527,45
900	x	1500	868	x	1676	x	770	18628	550,80
950	x	1000	917	x	1118	x	340	18640	292,75
950	x	1050	917	x	1174	x	380	18641	302,60
950	x	1100	917	x	1230	x	420	18642	330,85
950	x	1150	917	x	1285	x	460	18643	380,35
950	x	1200	917	x	1342	x	500	18644	443,35
950	x	1300	917	x	1453	x	580	18645	464,05
950	x	1400	917	x	1562	x	650	18646	553,35
950	x	1500	917	x	1676	x	730	18647	575,40
1000	x	1050	965	x	1174	x	350	18660	306,50
1000	x	1100	965	x	1230	x	390	18661	327,85
1000	x	1150	965	x	1285	x	420	18662	353,05
1000	x	1200	965	x	1342	x	460	18663	422,25
1000	x	1300	965	x	1453	x	540	18664	478,50
1000	x	1400	965	x	1562	x	620	18665	561,10
1000	x	1500	965	x	1676	x	700	18666	579,35
1000	x	1600	965	x	1782	x	770	18667	692,15
1050	x	1100	1014	x	1230	x	350	18680	314,50
1050	x	1150	1014	x	1285	x	390	18681	316,80
1050	x	1200	1014	x	1342	x	430	18682	357,15
1050	x	1300	1014	x	1453	x	510	18683	476,30
1050	x	1400	1014	x	1562	x	580	18684	508,10
1050	x	1500	1014	x	1676	x	660	18685	593,25
1050	x	1600	1014	x	1782	x	740	18686	631,05

- Please inform us about exact pipe dimensions
- Please specify the endseal closed (AKG) or split (AKO)
- Prices incl. stainless steel straps, rubber CR
- Special sizes, Nitrile or Silikone rubber on request

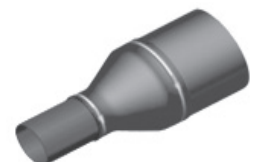

Casing endseals type AKG/AKO



Product group 750

Type AKG = closed Version

Type AKO = split Version

DN1 mm	X	DN2 mm	Cutting size in mm			L	Art.-No.	€/pcs.	
			Ø1	Ø2					
1100	x	1150	1062	x	1285	x	360	18690	290,05
1100	x	1200	1062	x	1342	x	400	18691	311,25
1100	x	1300	1062	x	1453	x	470	18692	459,20
1100	x	1400	1062	x	1562	x	550	18693	510,65
1100	x	1500	1062	x	1676	x	630	18694	597,40
1100	x	1600	1062	x	1782	x	700	18695	635,20
1150	x	1200	1110	x	1342	x	360	18700	310,00
1150	x	1300	1110	x	1453	x	440	18701	387,90
1150	x	1400	1110	x	1562	x	520	18702	466,45
1150	x	1500	1110	x	1676	x	600	18703	545,95
1150	x	1600	1110	x	1782	x	670	18704	624,70
1150	x	1700	1110	x	1900	x	750	18705	722,55
1150	x	1800	1110	x	2002	x	830	18706	837,35
1150	x	1900	1110	x	2123	x	910	18707	936,80
1150	x	2000	1110	x	2222	x	980	18708	1,023,20
1200	x	1300	1159	x	1453	x	410	18720	362,00
1200	x	1400	1159	x	1562	x	480	18721	489,80
1200	x	1500	1159	x	1676	x	560	18722	542,30
1200	x	1600	1159	x	1782	x	640	18723	632,20
1200	x	1700	1159	x	1900	x	720	18724	713,10
1200	x	1800	1159	x	2002	x	790	18725	792,40
1200	x	1900	1159	x	2123	x	880	18726	837,30
1200	x	2000	1159	x	2222	x	940	18727	1,004,65
1300	x	1400	1255	x	1562	x	420	18740	388,90
1300	x	1500	1255	x	1676	x	500	18741	484,65
1300	x	1600	1255	x	1782	x	570	18742	563,65
1300	x	1700	1255	x	1900	x	650	18743	660,60
1300	x	1800	1255	x	2002	x	720	18744	740,00
1300	x	1900	1255	x	2123	x	810	18745	873,70
1300	x	2000	1255	x	2222	x	880	18746	971,15

- Please inform us about exact pipe dimensions
- Please specify the endseal closed (AKG) or split (AKO)
- Prices incl. stainless steel straps, rubber CR
- Special sizes, Nitrile or Silikone rubber on request



Casing endseals type ASTM

Price incl. one additional outlet



Product group 800

Dimensions DN in mm			Art.-No.	€/pcs.
50	x	200	18803	176,80
50	x	250	18804	230,50
50	x	300	18805	273,85
50	x	400	18807	302,30
50	x	500	18808	460,85
65	x	250	18822	238,15
65	x	300	18823	281,55
65	x	400	18825	375,45
65	x	500	18826	476,15
80	x	200	18830	229,30
80	x	250	18831	238,15
80	x	300	18832	281,55
80	x	400	18833	375,45
80	x	500	18834	476,15
100	x	200	18840	200,25
100	x	250	18841	243,50
100	x	300	18842	287,10
100	x	350	18843	330,45
100	x	400	18844	373,80
100	x	500	18845	469,20
125	x	200	18860	206,70
125	x	250	18861	250,15
125	x	300	18862	293,45
125	x	400	18864	380,40
125	x	500	18865	478,10
150	x	250	18880	256,60
150	x	300	18881	300,10
150	x	350	18882	343,30
150	x	400	18883	473,85
150	x	500	18885	486,80
150	x	600	18886	599,90
150	x	700	18887	712,55
150	x	800	18888	725,15
200	x	300	18900	335,35
200	x	350	18901	356,55
200	x	400	18902	399,95
200	x	450	18903	443,35
200	x	500	18904	486,70
200	x	600	18905	712,55
200	x	700	18906	790,45
200	x	800	18907	834,25

Standard price incl. one additional outlet

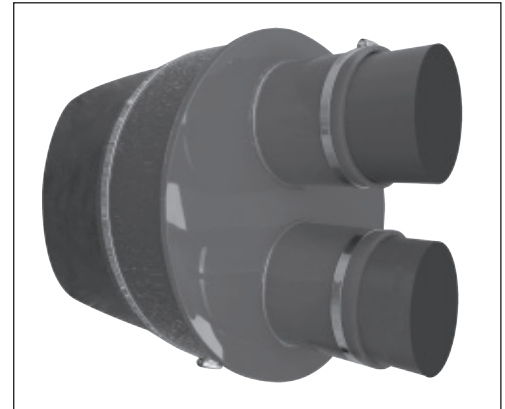

Further additional outlet	Art.-No. 19702	18,55 €
---------------------------	----------------	----------------

Price incl. stainless steel tightening straps

Casing endseals type ASTM

Price incl. one additional outlet



Product group 800

Dimensions DN in mm			Art.-No.	€/pcs.
250	x	350	18920	369,70
250	x	400	18921	413,10
250	x	450	18922	456,30
250	x	500	18923	485,95
250	x	550	18924	543,30
250	x	600	18925	618,45
250	x	700	18926	738,70
250	x	800	18927	828,95
250	x	900	18928	999,35
250	x	1000	18929	1.129,45
300	x	400	18940	426,15
300	x	450	18941	469,25
300	x	500	18942	512,90
300	x	550	18943	556,25
300	x	600	18944	599,75
300	x	650	18945	669,05
300	x	700	18946	712,55
300	x	800	18947	851,50
300	x	900	18948	990,55
300	x	1000	18949	1.129,45
350	x	450	18960	482,50
350	x	500	18961	525,70
350	x	550	18962	569,10
350	x	600	18963	612,85
350	x	700	18964	730,00
350	x	800	18965	875,50
350	x	900	18966	1.025,40
400	x	500	18980	538,95
400	x	550	18981	582,40
400	x	600	18982	625,60
400	x	650	18983	669,20
400	x	700	18984	712,55
400	x	750	18985	790,80
400	x	800	18986	834,25
400	x	900	18987	990,55
400	x	1000	18988	1.146,90
450	x	550	19000	595,15
450	x	600	19001	638,75
450	x	650	19002	682,35
450	x	700	19003	725,55
450	x	800	19004	851,50
450	x	1000	19006	1.181,65

Standard price incl. one additional outlet



Further additional outlet	Art. No. 19702	18,55 €
---------------------------	----------------	---------

Price incl. stainless steel tightening straps

Casing endseals type ASTM

Price incl. one additional outlet



Product group 800

Dimensions DN in mm			Art.-No.	€/pcs.
500	x	600	19010	651,80
500	x	650	19011	695,20
500	x	700	19012	738,75
500	x	750	19013	782,15
500	x	800	19014	825,65
500	x	900	19015	955,80
500	x	1000	19016	1.129,45
500	x	1100	19017	1.303,25
500	x	1200	19018	1.406,70
550	x	650	19030	708,25
550	x	700	19031	751,75
550	x	800	19032	839,20
550	x	900	19033	973,05
600	x	700	19040	764,70
600	x	750	19041	808,20
600	x	800	19042	851,50
600	x	850	19043	895,10
600	x	900	19044	938,30
600	x	1000	19045	1.077,40
600	x	1100	19046	1.268,40
650	x	750	19060	777,65
650	x	800	19061	864,65
650	x	900	19062	951,60
650	x	1000	19063	1.094,85
700	x	800	19070	877,75
700	x	850	19071	921,10
700	x	900	19072	965,10
700	x	1000	19073	1.051,45
700	x	1100	19074	1.207,10
700	x	1200	19075	1.407,45
700	x	1300	19076	1.616,15
700	x	1400	19077	1.824,40
750	x	850	19090	934,20
750	x	900	19091	977,35
750	x	950	19092	995,85
750	x	1000	19093	1.064,25
750	x	1200	19095	1.433,65
800	x	900	19100	990,55
800	x	950	19101	1.034,10
800	x	1000	19102	1.077,40
800	x	1100	19103	1.164,35
800	x	1200	19104	1.320,75
800	x	1300	19105	1.547,05
800	x	1400	19106	1.772,95

Standard price incl. one additional outlet



Further additional outlet	Art. No. 19070	18,55 €
---------------------------	----------------	---------

Price incl. stainless steel tightening straps

Casing endseals type ASTM

Price incl. one additional outlet



Product group 800

Dimensions DN in mm			Art.-No.	€/pcs.
850	x	950	19120	1.003,60
850	x	1000	19121	1.047,00
850	x	1100	19122	1.134,10
900	x	1000	19130	1.103,45
900	x	1050	19131	1.146,90
900	x	1100	19132	1.190,15
900	x	1200	19133	1.277,30
900	x	1300	19134	1.442,30
900	x	1400	19135	1.685,35
900	x	1500	19136	1.929,85
950	x	1050	19140	1.159,95
950	x	1100	19141	1.203,45
950	x	1200	19142	1.290,15
950	x	1300	19143	1.459,70
1000	x	1100	19150	1.216,45
1000	x	1200	19151	1.303,25
1000	x	1300	19152	1.390,20
1000	x	1400	19153	1.563,90
1000	x	1500	19154	1.825,40
1050	x	1200	19170	1.316,35
1050	x	1300	19171	1.403,30
1050	x	1400	19172	1.580,75
1050	x	1500	19173	1.849,75
1100	x	1200	19180	1.277,95
1100	x	1300	19181	1.416,20
1100	x	1400	19182	1.503,25
1100	x	1500	19183	1.685,35
1200	x	1400	19190	1.529,25
1200	x	1500	19191	1.616,15
1200	x	1600	19192	1.806,80

Standard price incl. one additional outlet

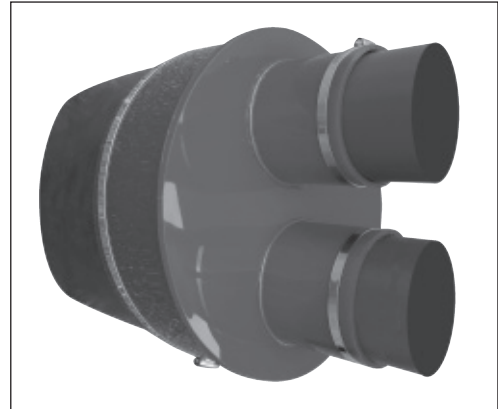

Further additional outlet	Art. No. 19702	18,55 €
---------------------------	----------------	----------------

Price incl. stainless steel tightening straps



Tubular shrinksleeves SOK, thin wall

	Type	Art.-No.	€/pcs.
Tubular shrinksleeve no adhesive	SOK 25,4/12,7 x 30 m*	15460	295,00
	SOK 50,8/24,4 x 30 m*	15470	323,50
	SOK 76/38 x 30 m*	15480	447,00

* If roll length differs, prices pro rata

Tubular shrink sleeves 4PMSA, medium wall – with adhesive

	Ø Inside as supplied	Ø Inside fully recovered	Wall thickness fully recovered	Length	Art.-No.	€/pcs.
Shrink sleeve Type	mm	mm	mm	mm		
4PMSA 95/25	95	25	3	1000	15504	38,90
4PMSA 115/34	115	34	3	1000	15505	51,40
4PMSA 140/42	140	42	3	1000	15506	71,05
4PMSA 160/50	160	50	2,9	1000	15507	80,20
4PMSA 180/60	180	60	2,9	1000	15511	83,35
4PMSA 235/65	235	65	3	1000	15508	145,10
4PMSA 265/75	265	75	3	1000	15509	153,55
4PMSA 300/90	300	90	2,8	1000	15510	176,35

Tubular shrink sleeves 4PMS, medium wall – without adhesive

Shrink sleeve Type	Ø Inside as supplied	Ø Inside fully recovered	Wall thickness fully recovered	Length	Art.-No.	€/pcs.
	mm	mm	mm	mm		
4PMS 95/25	95	25	3	1000	15531	35,30
4PMS 115/34	115	34	3	1000	15532	46,70
4PMS 140/42	140	42	3	1000	15533	63,25
4PMS 160/50	160	50	2,9	1000	15534	72,85
4PMS 180/60	180	60	2,9	1000	15536	75,70
4PMS 200/65	200	65	3	1000	15537	124,60
4PMS 235/65	235	65	2,9	1000	15538	125,10
4PMS 265/75	265	75	3	1000	15539	126,85
4PMS 300/90	300	90	2,8	1000	15540	134,25
4PMS 350/150	350	150	2,8	1000	15541	136,50
4PMS 400/150	400	150	4	1000	15543	167,25

Labyrinth Wall Penetration Seals and Filling Blocks for Pre-insulated Pipes



Product group 350

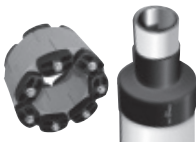

Description	for casing pipe OD mm	Pack. unit	Art. No.	€/pcs.
Labyrinth Wall Penetration Seals 	65	100	12900	6,15
	75	100	12901	6,50
	90	80	12902	6,85
	110	80	12903	7,95
	125	50	12904	8,25
	140	50	12905	8,95
	143	40	12906	9,00
	160	40	12907	9,45
	180	35	12908	11,20
	200	30	12909	12,20
	225	30	12910	13,25
	250	25	12911	13,40
	280	25	12912	14,80
	315	25	12913	16,95
	355	20	12914	19,20
	400	20	12915	20,45
	450	20	12916	24,35
	500	20	12917	26,10
	560	10	12918	30,20
	630	10	12919	32,40
670	10	12920	33,80	
710	15	12921	38,25	
800	10	12922	43,80	
900	10	12923	48,50	
1000	4	12924	54,10	
1200	4	12926	79,20	

Description	rubber width	for carrier pipe size	Art. No.	€/pcs.
Filling blocks for pre-insulated twin pipes high-quality EPDM 	40 mm	DN 20 (26,9 mm)	11040	15,15
		DN 25 (33,70mm)	11041	15,50
		DN 32 (42,4 mm)	11042	15,50
		DN 40 (48,3 mm)	11043	17,10
		DN 50 (60, 3 mm)	11044	20,25
		DN 65 (76, 1mm)	11045	21,40
		DN 80 (88,9 mm)	11046	28,55
		DN 100 (114, 3mm)	11047	37,80
		DN 125 (139,7 mm)	11048	53,80
		DN 150 (168,3 mm)	11049	58,50
		DN 200 (219,1 mm)	11050	91,80

Description	Set components	Pack. unit	Art. Nr.	€/pcs.
Cable outlet-seal for ID 50 mm 	4 x IL 275 C und 1 x CSS 10	1	16089	52,25

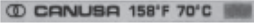

Product group 500



Description	Type	Art.-No.	€/pcs.
 Temperature indicator	70°C	15561	2,60
 Sandpaper 50 grit	Roll à 50 m	15563	91,85
 Silicone roller		15564	112,85

Anti-corrosion-tapes 4 pipes

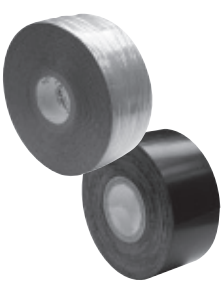

Product group 600

Single tape system	Description		Core Ø in mm	Width mm	Length in m/roll	pcs/carton	Art.-No.	€/roll		
	DUO 3-ply tape	DUO40 4 pipes		41	30	15	18	16500	19,50	
DUO40 4 pipes		41	50	15	12	16501	29,10			
MONO 2-ply tape	DUO40 4 pipes		41	100	15	6	16502	58,10		
							Litre/Can	kg/package	Art.-No.	€/package
	Primer HT for DUO40 4 pipes		-	1	1	-	16580	39,85		
	Primer HT for DUO40 4 pipes		-	5	5	-	16581	144,80		
	Mono Tape 710.35		41	50	15	30	16541	26,95		
	Mono Tape 710.35		41	100	15	15	16542	53,25		
							Litre/Can	kg/package	Art.-No.	€/package
	Primer 700-23 for Mono Tape 710.35		-	1	1	-	16592	30,85		

Two tape system	Description		Core Ø in mm	Width mm	Length in m/roll	pcs/carton	Art.-No.	€/roll	
		Inner layer	IT N15	41	30	7.5	18	16660	20,20
IT N15			41	50	7.5	12	16661	32,60	
IT N15			41	100	7.5	6	16662	62,50	
Outer layer	OT PE 3	41	30	20	18	16665	20,40		
	OT PE 3	41	50	20	12	16666	33,55		
	OT PE 3	41	100	20	6	16667	65,20		
	OT PE 5	41	30	15	18	16675	15,60		
	OT PE 5	41	50	15	12	16676	25,05		
	OT PE 5	41	50	30	12	16677	50,05		
	OT PE 5	41	100	30	6	16678	100,05		
						Litre/Can	kg/package	Art.-No.	€/package
Primer HT for IT N15/OT PE3 and OT PE5			1	1		16580	39,85		
Primer HT for IT N15/OT PE3 and OT PE5			5	5		16581	148,80		
	Wrapping machine for tape width up to 100 mm, for core 41 mm*						16600	1.085,35*	

* No discounts on wrapping machines

Anti-corrosion-tapes 4 pipes consumption per joint



Product group 600

Single tape systems					Class B/30			Class B/50			Class C/50		
Pipe diameter		DN Pipe (ISO)	Width	Primer consumption per w.joint	Wrap with 1 x 50% overlap (2-layers)			One wrap with 50% overlap and one wrap with 10 mm overlap (3-layers)			Two wraps with 50% overlap (4-layers)		
DN	inch	mm	mm	Litre	meters tape	m ²	Mono Tape €/w.joint	meters tape	m ²	Duo40 4 pipes €/w.joint	meters tape	m ²	Duo40 4 pipes €/w.joint
25	1	33,7	30	0,01	2,96	0,09	-	4,45	0,13	5,78	5,93	0,18	7,71
40	1,5	48,3	30	0,02	4,25	0,13	-	6,37	0,19	8,28	8,50	0,25	11,05
50	2	60,3	30	0,02	5,30	0,16	-	7,96	0,24	10,34	10,61	0,32	13,79
65	2,5	76,1	50	0,02	4,02	0,20	7,22	6,02	0,30	11,69	8,03	0,40	15,58
80	3	88,9	50	0,03	4,69	0,23	8,43	7,04	0,35	13,65	9,38	0,47	18,21
100	4	114,3	50	0,04	6,03	0,30	10,84	9,05	0,45	17,55	12,07	0,60	23,41
150	6	168,3	50	0,05	8,88	0,44	15,96	13,32	0,67	25,85	17,77	0,89	34,46
200	8	219,1	50	0,07	11,56	0,58	20,78	17,35	0,87	33,65	23,13	1,16	44,87
250	10	273,1	100	0,09	7,21	0,72	25,58	10,81	1,08	41,87	14,41	1,44	55,83
300	12	323,9	100	0,10	8,55	0,85	30,34	12,82	1,28	49,66	17,10	1,71	66,21
350	14	355,6	100	0,11	9,38	0,94	33,31	14,08	1,41	54,52	18,77	1,88	72,70
400	16	406,4	100	0,13	10,72	1,07	38,07	16,09	1,61	62,31	21,45	2,14	83,08
450	18	457	100	0,14	12,06	1,21	42,81	18,09	1,81	70,07	24,12	2,41	93,42
500	20	508	100	0,16	13,41	1,34	47,59	20,11	2,01	77,89	26,81	2,68	103,85
600	24	610	100	0,19	16,10	1,61	57,15	24,15	2,41	93,53	32,20	3,22	124,70
700	28	711	100	0,22	18,76	1,88	66,61	28,14	2,81	109,01	37,53	3,75	145,35
800	32	813	100	0,26	21,45	2,15	76,16	32,18	3,22	124,65	42,91	4,29	166,20
900	36	914	100	0,29	24,12	2,41	85,63	36,18	3,62	140,14	48,24	4,82	186,85
1000	40	1016	100	0,32	26,81	2,68	95,18	40,22	4,02	155,78	53,62	5,36	207,70

Two tape systems					IT N15, Wrap with 50% overlap (2-layers)		OT PE3, Wrap with 10 mm overlap (1-layer)		OT PE5, Wrap with 50% overlap (2-layers)			Total cost for Two Tape System IT N15/OT PE 3 Class B/30	Total cost for Two Tape System IT N15/OT PE 5 Class C/30		
Pipe diameter		DN Pipe (ISO)	Width	Primer consumption per w.joint	meters tape	m ²	IT N15 €/w.j.	meters tape	m ²	OT PE3 €/w.j.	meters tape	m ²	OT PE5 €/w.j.	€/w.j.	€/w.j.
DN	inch	mm	mm	Litre	meters tape	m ²	IT N15 €/w.j.	meters tape	m ²	OT PE3 €/w.j.	meters tape	m ²	OT PE5 €/w.j.	€/w.j.	€/w.j.
25	1	33,7	30	0,01	2,96	0,09	7,98	2,22	0,07	2,27	2,96	0,09	3,08	10,25	11,07
40	1,5	48,3	30	0,02	4,25	0,13	11,44	3,19	0,10	3,25	4,25	0,13	4,42	14,69	15,86
50	2	60,3	30	0,02	5,30	0,16	14,29	3,98	0,12	4,06	5,30	0,16	5,52	18,34	19,80
65	2,5	76,1	50	0,02	4,02	0,20	17,46	2,51	0,13	4,21	4,02	0,20	6,71	21,67	24,17
80	3	88,9	50	0,03	4,69	0,23	20,39	2,93	0,15	4,92	4,69	0,23	7,84	25,31	28,23
100	4	114,3	50	0,04	6,03	0,30	26,22	3,77	0,19	6,32	6,03	0,30	10,07	32,55	36,30
150	6	168,3	50	0,05	8,88	0,44	38,61	5,55	0,28	9,31	8,88	0,44	14,83	47,92	53,44
200	8	219,1	50	0,07	11,56	0,58	50,26	7,23	0,36	12,12	11,56	0,58	19,31	62,39	69,58
250	10	273,1	100	0,09	7,21	0,72	60,06	4,00	0,40	13,05	7,21	0,72	24,04	73,11	84,09
300	12	323,9	100	0,10	8,55	0,85	71,23	4,75	0,47	15,48	8,55	0,85	28,51	86,71	99,74
350	14	355,6	100	0,11	9,38	0,94	78,20	5,21	0,52	17,00	9,38	0,94	31,30	95,20	109,50
400	16	406,4	100	0,13	10,72	1,07	89,37	5,96	0,60	19,42	10,72	1,07	35,77	108,80	125,14
450	18	457	100	0,14	12,06	1,21	100,50	6,70	0,67	21,84	12,06	1,21	40,22	122,34	140,72
500	20	508	100	0,16	13,41	1,34	111,72	7,45	0,74	24,28	13,41	1,34	44,71	135,99	156,42
600	24	610	100	0,19	16,10	1,61	134,15	8,94	0,89	29,15	16,10	1,61	53,69	163,30	187,83
700	28	711	100	0,22	18,76	1,88	156,36	10,42	1,04	33,98	18,76	1,88	62,57	190,34	218,93
800	32	813	100	0,26	21,45	2,15	178,79	11,92	1,19	38,86	21,45	2,15	71,55	217,64	250,34
900	36	914	100	0,29	24,12	2,41	201,00	13,40	1,34	43,68	24,12	2,41	80,44	244,68	281,44
1000	40	1016	100	0,32	26,81	2,68	223,43	14,90	1,49	48,56	26,81	2,68	89,42	271,99	312,85

The determined quantities of material contain a surcharge of approx. 5%, because in practice the wrapping is done with a little more overlap and factory wrappings of different thicknesses and various welding connection systems, e.g. Push-in welding sockets are not considered separately. The stated primer consumption is based on an average empirical value and can vary slightly depend on the application method and type of primer.

Anti-corrosion-tapes 4 pipes



Product group 600

Product	Description	Core Ø in mm	Width mm	Length in m/roll	packing unit	Art.-No.	€/roll
	Alu Tape 30	76	50	15	6	16550	26,95
	Alu Tape 30	76	100	15	6	16551	53,25

Butyle Filler for irregular shapes and cavities

	Description	packing unit	Art.-No.	€/pcs
	Butyl filler á 6 kg	1 x 6 kg	16636	98,50

 Class A-30	ISO-Petrolatum tape PE – 1.5 mm 2 Layer-system	Width	Length	packing unit	Art.-No.	€/roll
	Roll	50 mm	10 m	24	16560	8,95
	Roll	100 mm	10 m	12	16561	17,70
	Roll	200 mm	10 m	3	16562	35,20
	Roll	300 mm	10 m	-	16563	52,60



Product group 600

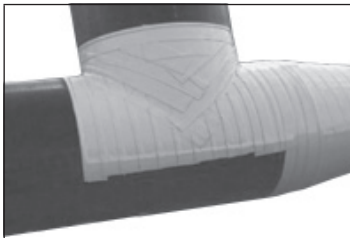

Stopaq CZ tape for complicated pipeline parts
DVGW approved to DIN 30672/EN 12068 class A/30

Description	width	length	packing unit	Art.-No.	€/roll
CZ-Tape roll	50 mm	10 m	12	16620	84,25
CZ-Tape roll	100 mm	10 m	6	16621	121,60
Outerwrap Mono Tape 710.35, underground	50 mm	15 m	30	16541	26,95
Outerwrap Mono Tape 710.35, underground	100 mm	15 m	15	16542	53,25
Outerwrap Alu Tape 30, above ground	50 mm	15 m	6	16550	26,95
Outerwrap Alu Tape 30, above ground	100 mm	15 m	6	16551	53,25

Espansit II tape for complicated pipeline parts



Description	width	length	packing unit	Art.-No.	€/roll
Roll	50 mm	10 m	10	16627	51,05
Roll	100 mm	10 m	4	16628	87,45

KU Special adhesive tape 4 pipes - highly flexible

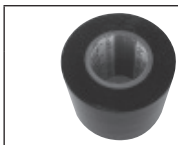

Description	packing unit	Art.-No.	€/roll
KU tape 50 mm x 0,19 mm x 10 m black	80	15550	6,45

Product group 225



Description	Type	packing unit	Art.-No.	€/pcs.
Corrosion protection-filler compound for parts (underground)	Stopaq FN 4100 bag à 2 kg	9	16630	60,50
Corrosion protection compound for parts (above ground)	Stopaq FN 4200 cartridge 0,53 kg	20	16631	76,10







Description	Type	packing unit	Art.-No.	€/pcs.
Grouting tool* for 0,53 kg cartridge	for 600 ml	1	11104	135,50*

* No discount on grouting tool

Fibercoat Ultra, Rock Shield Net/ -Fleece, Pipecoat Plus 4 pipes

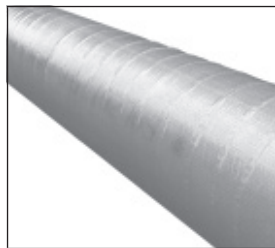



Product group 650

	<p>Fibercoat Ultra – GRP glassfibre-reinforced Polyester laminate. curing by UV-light, pre impregnated, ready to use, thickness per layer 0.9 ± 0,1 mm</p>		
Description		Art.-No.	€/pcs.
Roll 150 mm x 15 m (2,25 m ² / Roll)		16708	210,55
Roll 300 mm x 15 m (4,5 m ² / Roll)		16709	323,85
Adhesive tape transparent 50 mm x 66 m		16760	5,45
Stretchfoil 0,5 m x 300 m, 20 µm thick		16765	22,20
Gloves for Fibercoat Ultra application		16770	9,45
	<p>UV-Spot 400 Watt*</p>	<p>16750</p>	<p>2.415,90*</p>
	<p>Product group 960 Shore D measuring tool* with drag indicator for hardness test of Fibercoat Ultra and Pipecoat Plus</p>	<p>20304</p>	<p>474,25*</p>

* No discount on tools

Description	Thickness	Art.-No.	€/pcs.
 <p>Rock Shield Fleece colorful* Width 1000 mm roll à 25 m. 1000 g/m²</p>	<p>7 - 8 mm</p>	<p>16720</p>	<p>211,30</p>



* Not a stock item, please consider lead time.
 Other roll widths and/or weight are available on request.

Description	Dimensions	Art.-No.	€/pcs.
 <p>Pipecoat Plus water activated GRP tape, ready to use, water-activated for mechanical pipe protection</p>	 <p>100 mm x 10 m</p>	<p>16711</p>	<p>74,10</p>
	<p>150 mm x 10 m</p>	<p>16712</p>	<p>98,50</p>
<p>Adhesive tape transparent</p>	<p>50 mm x 66 m</p>	<p>16760</p>	<p>5,45</p>

Pressio®-Rings wall penetration seal 4 pipes



Product group 200

Pressio® Seals are made against pressing water			Standard		Split Version		District heating	
								
Core hole/ wallsleeve	Carrier pipe OD in mm		Stainless steel pressure plates, Bolts V2A, Rubber 1 x 40 mm EPDM		Stainless steel pressure plates, <i>split</i> Version, bolts V2A, Rubber 1 x 40 mm EPDM		Stainless steel pressure plates, bolts V2A, Rubber 2x40 mm EPDM	
	mm	min.	max.	Art.-No.	€/pcs.	Art.-No.	€/pcs.	Art.-No.
50	6	12	10500	30,30	10600	33,35	-	-
70	10	22	10505	30,70	10605	35,80	-	-
70	24	32	10506	30,70	10606	35,80	*	-
70	32	41	10507	30,70	10607	35,80	*	-
80	20	28	10510	35,80	10610	42,50	*	-
80	28	32	10514	35,80	10614	42,50	*	-
80	32	40	10511	35,80	10611	42,50	*	-
80	40	50	10512	35,80	10612	42,50	-	-
100	15	22	10515	51,05	10615	61,15	-	-
100	20	28	10516	51,05	10616	61,15	*	-
100	25	32	10517	51,05	10617	61,15	*	-
100	32	40	10518	51,05	10618	61,15	*	-
100	36	44	10519	51,05	10619	61,15	*	-
100	41	51	10489	51,05	-	-	*	-
100	46	56	10520	51,05	10620	61,15	*	-
100	55	65	10521	51,05	10621	61,15	*	-
125	35	40	10523	71,15	10623	81,40	-	-
125	45	50	10524	71,15	10624	81,40	-	-
125	55	64	10525	71,15	10625	81,40	10702	164,25
125	61	70	10526	71,15	10626	81,40	10700	164,25
125	70	78	10527	71,15	10627	81,40	10701	164,25
150	35	40	10529	101,35	10629	116,60	*	-
150	46	54	10530	101,35	10630	116,60	10703	202,65
150	56	66	10531	101,35	10631	116,60	10704	202,65
150	69	78	10532	101,35	10632	116,60	10705	202,65
150	79	91	10533	101,35	10633	116,60	10708	202,65
150	85	94	10534	101,35	10634	116,60	10706	202,65
150	90	97	10536	101,35	10636	116,60	10745	202,65
150	98	110	10535	101,35	10635	116,60	10707	202,65
150	110	114,3	10537	101,35	10637	116,60	10762	202,65
187-191**	69	78	01563	139,10	01663	157,65	10763	242,40
187-191**	88	103	01564	139,10	01664	157,65	10764	242,40
187-191**	108	115	01565	139,10	01665	157,65	10765	242,40
187-191**	119	128	01566	139,10	01666	157,65	10766	242,40
187-191**	135	144	01567	139,10	01667	157,65	10767	242,40
200	88	103	10540	139,10	10640	157,65	10709	242,40
200	108	115	10541	139,10	10641	157,65	10710	242,40
200	116	126	10542	139,10	10642	157,65	10713	242,40
200	119	128	10543	139,10	10643	157,65	10711	242,40
200	125	135	10547	139,10	10647	157,65	10760	242,40
200	132	141	10544	139,10	10644	157,65	*	-
200	135	144	10545	139,10	10645	157,65	10712	242,40
200	140	150	10548	139,10	*	-	10761	242,40
200	150	160	10546	139,10	10646	157,65	10714	242,40
250	135	144	10550	194,75	10650	213,25	10715	316,55
250	140	149	10551	194,75	10651	213,25	10716	316,55
250	150	159	10552	194,75	10652	213,25	10717	316,55
250	156	165	10553	194,75	10653	213,25	10718	316,55
250	165	175	10554	194,75	10654	213,25	10721	316,55
250	174	181	10555	194,75	10655	213,25	10719	316,55
250	178	187	10556	194,75	10656	213,25	10720	316,55
250	197	202	10557	194,75	10657	213,25	10722	316,55
250	204	210	10558	194,75	10658	213,25	10723	316,55



* Available on request/ Pressio® Individual special version up to DN 3000 on request

** made for KG2000/KG-Rohr DN200

Pressio®-Rings wall penetration seal 4 pipes



Product group 200



Pressio® Seals are made against pressing water			Standard		Split Version		District heating	
								
Core hole/ wallsleeve	Carrier pipe OD in mm		Stainless steel pressure plates, Bolts V2A, Rubber 1 x 40 mm EPDM		Stainless steel pressure plates. <i>split</i> Version, bolts V2A, Rubber 1 x 40 mm EPDM		Stainless steel pressure plates, bolts V2A, Rubber 2x40 mm EPDM	
	mm	min.	max.	Art.-No.	€/pcs.	Art.-No.	€/pcs.	Art.-No.
300	178	187	10565	256,90	10665	296,65	10725	413,20
300	193	204	10566	256,90	10666	296,65	10726	413,20
300	198	207	10567	256,90	10667	296,65	10727	413,20
300	218	226	10568	256,90	10668	296,65	10728	413,20
300	224	233	10564	256,90	10664	296,65	10724	413,20
300	242	251	10569	256,90	10669	296,65	10729	413,20
350	224	233	10570	306,00	10670	350,90	10730	508,50
350	233	243	10574	306,00	10674	350,90	10759	508,50
350	249	258	10571	306,00	10671	350,90	10731	508,50
350	270	282	10572	306,00	10672	350,90	10732	508,50
350	279	288	10573	306,00	10673	350,90	10733	508,50
400	270	280	10575	414,55	10675	479,40	10734	639,60
400	279	288	10576	414,55	10676	479,40	10735	639,60
400	304	313	10577	414,55	10677	479,40	10736	639,60
400	314	323	10578	414,55	10678	479,40	10737	639,60
400	320	330	10579	414,55	10679	479,40	10738	639,60
500	354	364	01582	655,45	01682	753,50	10750	983,20
500	392	402	01583	655,45	01683	753,50	10752	983,20
500	400	412	01584	655,45	01684	753,50	10751	983,20
500	421	431	01585	655,45	01685	753,50	*	
600	450	464	01588	783,95	01688	901,55	10755	1178,50
600	494	504	01589	783,95	01689	901,55	*	
600	500	515	01590	783,95	01690	901,55	10756	1178,50
600	524	534	01591	783,95	01691	901,55	*	

* Available on request/ Pressio® Individual/ special version up to DN 3000 on request

Pressio®-Rings wall penetration seal 4 pipes



Product group 200

Pressio® seals are made against pressing water			S316 Ti		Drinking water		Blind	
								
Core hole/ wallsleeve	Carrier pipe OD in mm		Stainless steel pressure plates and bolts S316 Ti rubber: EPDM		Stainless steel pressure plates and bolts S304, rubber: EPDM with KTW/W 270**		Blind stainless steel pressure plates, bolts S304, rubber: EPDM	
	mm	min.	max.	Art.-No.	€/pcs.	Art.-No.	€/pcs.	Art.-No.
50	6	12	10300	36,40	10800	76,25	10585	30,30
70	10	22	10305	36,85	10805	78,15	10586	30,70
70	24	32	10306	36,85	10806	78,15		
70	32	41	10307	36,85	10807	78,15		
80	20	28	10310	43,00	10810	137,80	10587	35,80
80	32	40	10311	43,00	10811	137,80		
100	15	22	10315	61,30	10815	144,40	10596	51,05
100	20	28	10316	61,30	10816	144,40		
100	25	32	10317	61,30	10817	144,40		
100	32	40	10318	61,30	10818	144,40		
100	36	44	10319	61,30	10819	144,40		
100	46	56	10320	61,30	10820	144,40		
100	55	65	10321	61,30	10821	144,40		
125	55	64	10325	85,40	10825	182,15	10597	71,15
125	61	70	10326	85,40	10826	182,15		
125	70	78	10327	85,40	10827	182,15		
150	46	54	10330	121,65	10830	205,30	10598	101,35
150	56	66	10331	121,65	10831	205,30		
150	69	78	10332	121,65	10832	205,30		
150	79	91	10333	121,65	10833	205,30		
150	85	94	10334	121,65	10834	205,30		
150	98	110	10335	121,65	10835	205,30		
200	88	103	10340	166,90	10840	296,05	10591	139,10
200	108	115	10341	166,90	10841	296,05		
200	116	126	10342	166,90	10842	296,05		
200	119	128	10343	166,90	10843	296,05		
200	132	141	10344	166,90	10844	296,05		
200	135	144	10345	166,90	10845	296,05		
200	150	160	10346	166,90	10846	296,05		
250	135	144	10350	233,65	10850	397,25	10592	422,75
250	140	149	10351	233,65	10851	397,25		
250	150	159	10352	233,65	10852	397,25		
250	156	165	10353	233,65	10853	397,25		
250	165	175	10354	233,65	10854	397,25		
250	174	181	10355	233,65	10855	397,25		
250	178	187	10356	233,65	10856	397,25		
250	197	202	10357	233,65	10857	397,25		
250	204	210	10358	233,65	10858	397,25		



*Available on request / Pressio® individual special version up to DN 3000 on request
Rubber quality: NBR and EPDM for Pressio® seal with split version on request

** according to DVGW W270, Elastomer Guideline of UBA / KTW
BWL-G-Certificate of conformity
Attention: no stock item, please note delivery times!

Pressio®-Rings wall penetration seal 4 pipes



Product group 200



Pressio® seals are made against pressing water			S316 Ti		Drinking water		Blind	
								
Core hole/ wallsleeve	Carrier pipe OD in mm		Stainless steel pressure plates and bolts S316 Ti rubber: EPDM		Stainless steel pressure plates and bolts S304, rubber: EPDM with KTW/W 270**		Blind stainless steel pressure plates, bolts S304, rubber: EPDM	
	mm	min.	max.	Art.-No.	€/pcs.	Art.-No.	€/pcs.	Art.-No.
300	178	187	10365	308,35	10865	553,55	10593	618,75
300	193	204	10366	308,35	10866	553,55		
300	198	207	10367	308,35	10867	553,55		
300	218	226	10368	308,35	10868	553,55		
350	224	233	10370	367,10	10870	668,75	10594	752,25
350	249	258	10371	367,10	10871	668,75		
350	270	282	10372	367,10	10872	668,75		
400	270	280	10375	497,45	10875	838,25	10595	891,30
400	279	288	10376	497,45	10876	838,25		
400	304	313	10377	497,45	10877	838,25		
400	314	323	10378	497,45	10878	838,25		
400	320	330	10379	497,45	10879	838,25		
500	354	364	01382	786,55	10882	1.218,25	*	
500	392	402	01383	786,55	10883	1.218,25		
500	400	412	01384	786,55	10884	1.218,25		
500	421	431	01385	786,55	10885	1.218,25		
600	450	464	01388	940,75	10888	1.655,20	*	
600	494	504	01389	940,75	10889	1.655,20		
600	500	515	01390	940,75	10890	1.655,20		
600	524	534	01391	940,75	10891	1.655,20		



*Available on request / Pressio® individual special version up to DN 3000 on request
Rubber quality: NBR and EPDM for Pressio® seal with split version on request

** according to DVGW W270, Elastomer Guideline of UBA / KTW
BWLG-Certificate of conformity
Not a stock item, please consider lead time.

Pressio®-Rings Ringraumdichtungen 4 pipes





** Sealing range 8 - 10 mm with insert, 14 - 16 mm without insert			Pressio®-Rings with 2x extra drilling for cables 14 to 16 mm incl. insert for cables 8 to 10 mm and blind plugs** Rubber size 1 x 40 mm EPDM 		Pressio®-Rings with 2x extra drilling for cables 14 to 16 mm incl. insert for cables 8 to 10 mm and blind plugs** Rubber size 2 x 40 mm EPDM 	
OD	Carrier pipe		Art-No.	€/pcs.	Art-No.	€/pcs.
mm	min.	max.				
150	69	78	01500	116,60	01700	233,10
150	85	94	01501	116,60	01701	233,10
200	108	115	01502	157,65	01702	278,75
200	119	128	01503	157,65	01703	278,75
200	135	144	01504	157,65	01704	278,75
250	156	165	01505	213,25	01705	363,95
250	178	187	01506	213,25	01706	363,95
300	193	204	01507	296,65	01707	475,20
300	224	233	01508	296,65	01708	475,20

* Sealing range each 6 - 16 mm			Pressio®-Rings with 4 x 16 mm extra drilling incl. insert and blind plug* Rubber size 1 x 40 mm EPDM 		Pressio®-Rings with 4 x 16 mm extra drilling incl. insert and blind plug* Rubber size 2 x 40 mm EPDM 	
OD	Carrier pipe		Art-No.	€/pcs.	Art-No.	€/pcs.
mm	min.	max.				
250	156	165	01545	266,60	01745	455,00
250	178	187	01546	266,60	01746	455,00
300	193	204	01547	370,80	01747	593,95
300	224	233	01548	370,80	01748	593,95

Pressio®-Rings BlackLine wall penetration seal 4 pipes



Product group 210

Pressio® seals are made against pressing water			Split version		District heating		Blind	
								
Core hole/ wallsleeve	Carrier pipe OD in mm		Pressure plates PA6-30 split version bolts S316 Ti rubber 1 x 40 mm EPDM		Pressure plates PA6-30 split version bolts S316 Ti rubber 2 x 40 mm EPDM		Blind Pressure plates PA6-30 bolts S316 Ti rubber 1 x 40 mm EPDM	
	mm	min.	max.	Art.-No.	€/pcs.	Art.-No.	€/pcs.	Art.-No.
80	20	28	55610	30,25	-	-	55587	30,25
80	28	32	55614	30,25	-	-		
80	32	40	55611	30,25	-	-		
80	40	50	55612	30,25	-	-		
100	20	28	55616	43,05	-	-	55588	43,05
100	25	32	55617	43,05	-	-		
100	32	40	55618	43,05	-	-		
100	36	44	55619	43,05	-	-		
100	46	56	55620	43,05	-	-		
100	55	65	55621	43,05	-	-		
125	55	64	55625	60,05	-	-	55589	60,05
125	61	70	55626	60,05	55700	138,55		
125	70	78	55627	60,05	55701	138,55		
150	46	54	55630	85,50	-	-	55590	85,50
150	56	66	55631	85,50	55704	170,95		
150	69	78	55632	85,50	55705	170,95		
150	79	91	55633	85,50	55708	170,95		
150	85	94	55634	85,50	55706	170,95		
150	90	97	55636	85,50	-	-		
150	98	110	55635	85,50	55707	170,95		
200	108	115	55641	117,35	55710	204,50	55591	117,35
200	116	126	55642	117,35	55713	204,50		
200	119	128	55643	117,35	55711	204,50		
200	132	141	55644	117,35	-	-		
200	135	144	55645	117,35	55712	204,50		
200	140	150	55648	117,35	55761	204,50		
200	150	160	55646	117,35	55714	204,50		
250	135	144	55650	164,25	55715	267,00	-	-
250	140	149	55651	164,25	55716	267,00		
250	150	159	55652	164,25	55717	267,00		
250	156	165	55653	164,25	55718	267,00		
250	165	175	55654	164,25	55721	267,00		
250	174	181	55655	164,25	55719	267,00		
250	178	187	55656	164,25	55720	267,00		
250	197	202	55657	164,25	55722	267,00		
250	204	210	55658	164,25	-	-		
300	178	187	55665	216,75	55725	348,50		
300	193	204	55666	216,75	55726	348,50		
300	198	207	55667	216,75	55727	348,50		
300	218	226	55668	216,75	55728	348,50		
300	224	233	55664	216,75	55724	348,50		
300	242	251	55669	216,75	55729	348,50		
350	249	258	55671	258,05	55731	428,95	-	-
350	270	282	55672	258,05	-	-		

Pressio®-Rings Individual special versions 4 pipes



Product group 200

Pressio® Seals are made against pressing water







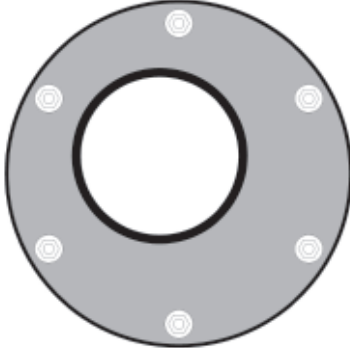

	Materials: rubber 1 x 40mm EPDM. pressure plates closed version in stainless steel S304 OD 800 mm and bigger, rubber 2 x 40 mm EPDM					
	Core drilled hole e.g. wall sleeve	Carrier pipe 0 - 65 mm	Carrier pipe 0 - 115 mm	Carrier pipe 0 - 160 mm	Carrier pipe 0 - 210 mm	Carrier pipe 0 - 250 mm
- 100 mm	205,85 €					
101 - 150 mm		249,10 €				
151 - 200 mm			301,80 €			
201 - 250 mm				422,75 €		
251 - 300 mm					618,75 €	

Up to OD 100 mm : Minimum annular space 17.5 mm. From OD 101 mm to 300 mm : Minimum annular space 22 mm.
Smaller spaces on request.

	0 - 324 mm	325 - 374 mm	375 - 424 mm	425 - 524 mm	525 - 624 mm	625 - 724 mm
350 mm	752,25 €					
400 mm	891,30 €					
450 mm	1.041,45 €	1.070,60 €				
500 mm	1.219,45 €	1.223,55 €	1.044,25 €			
550 mm	1.476,30 €	1.404,35 €	1.260,05 €			
600 mm	1.738,85 €	1.426,55 €	1.315,80 €	1.214,80 €		
650 mm	1.932,70 €	1.693,50 €	1.626,75 €	1.407,05 €		
700 mm		2.030,60 €	1.902,70 €	1.826,65 €	1.708,30 €	
750 mm			2.100,25 €	1.943,95 €	1.822,10 €	
800 mm					2.924,10 €	2.530,50 €

Prices for closed version **with one opening**. other sizes on request

Surcharge for Pressio®-Rings Individual special sealings



		For any additional drilling	32,80 €
		Split version	Basic price +10 %
		Stainless steel V4A - S316 Ti pressure plates	Basic price S304 +25 %
		Blind seal up to OD 650	see smallest stated medium pipe size
		Blind seal larger than OD 650	on request
		Oversized flange 20 mm bigger OD	Basic price +5%
		For preinsulated pipe 2 x 40 mm up to OD 750 mm	Basic price +50%
		Glue on flange 50 mm bigger OD	Basic price +20%
	NBR	Pressio Rings Individual with NBR rubber	Basic price +5%

Other materials (Viton, silicone, eg.) on request

Pressio®-Rings Individual special versions 4 pipes



Product group 200

Drinking water Individual					
	Materials: rubber 1 x 40 mm EPDM* pressure plates closed version in stainless steel S304 OD 800 mm and bigger. rubber 2 x 40mm EPDM				
Core drilled hole e.g. wall sleeve	Carrier pipe 0 - 65 mm	Carrier pipe 0 - 115 mm	Carrier pipe 0 - 160 mm	Carrier pipe 0 - 210 mm	Carrier pipe 0 - 250 mm
- 100 mm	239,95 €				
101 - 150 mm		327,15 €			
151 - 200 mm			451,65 €		
201 - 250 mm				591,80 €	
251 - 300 mm					794,25 €

Up to OD 100 mm : Minimum annular space 17.5 mm. From OD 101 mm to 300 mm : Minimum annular space 22 mm.
Smaller spaces on request.



* according to DVGW W270, Elastomer Guideline of UBA/KTW -BWL-G-Certificate of conformity

	0 - 324 mm	325 - 374 mm	375 - 424 mm	425 - 524 mm	525 - 624 mm	625 - 724 mm
350 mm	1.132,00 €					
400 mm	1.280,25 €					
450 mm	1.512,25 €	1.630,80 €				
500 mm	1.875,65 €	1.649,95 €	1.555,80 €			
550 mm	2.225,65 €	1.850,25 €	1.866,20 €			
600 mm	2.639,10 €	2.262,15 €	2.113,60 €	2.124,35 €		
650 mm	3.063,90 €	2.619,75 €	2.479,50 €	2.514,90 €		
700 mm		3.076,45 €	2.952,25 €	2.978,90 €	2.468,10 €	
750 mm			3.266,10 €	3.432,40 €	3.289,40 €	
800 mm					5.343,20 €	4.998,90 €

Prices for closed version with one opening. Other sizes on request

Express delivery on request.

For drawings ordered by the customer we reserve the right to charge an hourly fee up to 95,00 €.

	Description	Art.-No.	€/pcs.
	Retention bracket for 4 pipes Pressio® wall penetration seals up to DN 200	11030	4,80
	Ejection prevention clip Set 3 pcs. incl. screws and dowels for pressio seals up to 200 mm OD.	11031	148,40
	Ejection prevention clip Set 3 pcs. incl. screws and dowels for pressio seals up to 800 mm OD. Use two sets minimum for seals bigger than 600 mm	11032	180,20

Product group 560

	Description	Art.-No.	€/pcs.
	Butyle round strip 8 mm x 8 m	16190	24.95

Pressio®-Rings Universal wall penetration seal with onion-ring technology 4 pipes



Product group 200

	Ø core hole mm	Carrier pipe OD in mm	PU	Art.-No.	€/pcs.
 closed with extra large flange	100	up 18 to 65 mm	30	10488	69,10
 closed	100	up 18 to 65 mm	30	10490	54,75
 split foldable	100	20, 25, 32, 40, 50, 63 mm	30	10499	60,90
 closed	150	32, 40, 50, 63, 76, 90, 110 mm	10	10495	126,15
 closed	200	110, 125, 140, 160 mm	5	10493	193,75
 closed	250	160, 180, 200 mm Reduction rings incl. blind plugs		10496	280,45
 closed	300	200, 225, 250 mm Reduction rings incl. blind plugs		10497	321,50

Pressio® Universal BlackLine wall penetration seal with onion-ring technology



Product group 210

Pressio® Universal BlackLine	Ø Core drilled hole in mm	Carrier pipe OD in mm	Art-No.	€/pcs.
 split	80	25 - 50 mm	55487	53,40
 split	100	20, 25, 32, 40, 50, 63 mm	55499	53,40
 split	150	32, 40, 50, 63, 76, 90 and 110 mm	55495	110,65
 split	200	110, 125, 140, 160 mm	55493	169,95
 split	250	160, 180, 200 mm reduction rings split incl. blind plug	55496	246,00
 split	300	200, 225, 250 mm reduction rings split incl. blind plug	55497	282,00















Pressio® Extension-Rings for Pressio® Standard

For Pressio® OD	Extension to:	Description	Art.-No.	€/pcs.
50 mm	60 mm	Pressio Extension 50 mm to 60 mm	08015	4,25
70 mm	75-79 mm	Pressio Extension 70 mm to 75-79 mm	08020	4,25
80 mm	85 mm	Pressio Extension 80 mm to 85 mm	08000	4,50
80 mm	90 mm	Pressio Extension 80 mm to 90 mm	08001	4,50
80 mm	93 mm	Pressio Extension 80 mm to 93 mm	08002	4,50
100 mm	103,6 mm	Pressio Extension 100 mm to 103,6 mm	08010	5,75
100 mm	110 mm	Pressio Extension 100 mm to 110 mm	08011	5,75
100 mm	118-120 mm	Pressio Extension 100 mm to 118-120 mm	08012	5,75
100 mm	125 mm	Pressio Extension 100 mm to 125 mm	08013	8,00
150 mm	158-160 mm	Pressio Extension 150 mm to 158-160 mm	08030	12,45

Wall penetration seal Pressio® 4 cables®









Product group 200

Pressio® 4 cables® UNIVERSAL	Ø Core drilled hole in mm	Cables	Art.-No.	€/pcs.
 closed	50	with insert: 2x 6-10 mm without insert: 2x 10-16 mm incl. blind plugs	11011	64,65
 closed	100	18 to 65 mm onion-rings technology (5 mm per slat) incl. blind plugs	10490	54,75
 split	100	18-20, 25, 32, 40, 50, 63 mm onion-rings technology incl. blind plugs	10499	60,90
 split	100	EPDM 4x 6-30 mm onion-rings technology incl. blind plugs	11020	102,60
 split	100	Nitrile 4x 6-30 mm onion-rings technology incl. blind plugs	11024	102,60
 split	100	2x 6-32 mm 2x 6-26mm onion-rings technology incl. blind plugs	11021	102,60
 closed	100	with insert: 2x 6-10 mm without insert: 2x 10-16 mm 25-50 mm, onion-rings insert incl. blind plugs	11014	97,85
 closed	150	32, 40, 50, 63, 76, 90, 110 mm onion-rings technology incl. blind plugs	10495	126,15
 closed	150	3x 25-50 mm onion-rings insert incl. blind plugs	11025	212,05
 split	150	3x 25-50 mm onion-rings insert incl. blind plugs	11026	257,20
 split	150	7x 5-32 mm onion-rings insert incl. blind plugs	11027	258,60
 closed	200	110, 125, 140, 160 mm onion-rings technology incl. blind plugs	10493	193,75
 split	200	3x 25-50 mm 4x 5-32 mm onion-rings insert incl. blind plugs	11028	334,75

Wall penetration seal Pressio® 4 cables®



Product group 200

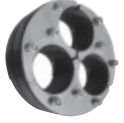

Pressio® 4 cables® FIXED	Ø Core drilled hole in mm	Cables	Art.-No.	€/pcs.
 split	50	2x 10-16 mm without blind plugs	11012	75,45
 closed or split	100	8, 2x 10, 12, 14, 16 and 18 mm incl. blind plugs	11010	114,95
 closed	100	32 mm and 2x 7 mm incl. blind plugs	11013	102,60
 split	100	2x 40 mm und 2x 32 mm without blind plugs *additional reducers for 40 mm to 32 mm see below	11017	102,60
 split	103,2 - 103,6 KG and KG 2000 pipe DN 100	2x 40 mm und 2x 32 mm without blind plugs *additional reducers for 40 mm to 32 mm see below	11018	102,60
 split	Pressio®-Reduction inlay 40 mm to 32 mm *used with Pressio seals ID 40 mm		08120	3,90
 closed	150	3 x 50	11080	131,30
 split	150	3 x 50	11081	172,75

Pressio® 4 cables® FIXED BlackLine	Ø Core drilled hole in mm	Cables	Art.-No.	€/pcs.
 split	100	8, 2x 10, 12, 14, 16 and 18 mm incl. blind plug	55010	100,80

Wall penetration seal Pressio® 4 cables®



Product group 200

Pressio® 4 cables® CUSTOM	Ø Core drilled hole in mm	ID Pressure plate mm	Cables	Art.-No.	€/pcs.
<p>These seals are drilled acc. to order. Please specify the exact number and diameter of the cables when ordering.</p>  <p>Example: Pressio® 4 cables® OD 100 mm, without drilling</p>	50	22 mm	Ø Cable from 2-19 mm incl. 2 drillings closed or split	11000	81,00
	70	43 mm	Ø Cable from 2-40 mm incl. 2 drillings closed or split	11005	94,25
	80	43 mm	Ø Cable from 2-40 mm incl. 2 drillings closed or split	11001	104,70
	100	66 mm	Ø Cable from 2-50 mm incl. 2 drillings closed or split	11002	111,70
	125	82 mm	Ø Cable from 2-63 mm incl. 2 drillings closed or split	11003	150,80
	150	112 mm	Ø Cable from 2-63 mm incl. 2 drillings closed or split	11004	189,85
	200	2x 56 mm 2x 70 mm	Ø Cable 2x from 2-50 mm and Ø Cable 2x from 2-63 mm incl. 2 drillings closed, splitting not possible	11006	258,20
	any additional outlet			11015	10,95

Flexible pipe district heating baseplate penetration 4 pipes



Product group 275

		Elbow radius							
		R = 800 mm		R = 1000 mm*		R = 1200 mm*			
	Set for baseplate	Product description	Art.-No.	€/pcs.	Art.-No.	€/pcs.	Art.-No.	€/pcs.	
single	Set 4 heating: Single district heating baseplate penetration	Scope of delivery complete set Basic set <ul style="list-style-type: none"> • Baseplate penetration incl. wall collar, one casing pipe for flexible preinsulated pipes up to 140 mm max. • One mounting stand: telescoping tripod incl. fixing accessories for tripod • One PVC-pipe bend • Protective endcaps Installation kit <ul style="list-style-type: none"> • One kit of centering ring (system raci) • One Pressio®-Rings seal Type FW 2x40 mm with oversized flange 							
		Basic set	Empty conduit system without sealing	09600	710,00	09659	780,00	09674	1.001,00
		Complete set (incl. installation kit)	for flexible preinsulated pipe OD 69 - 78 mm	09605	924,00	09660	1.016,00	09675	1.195,00
			for flexible preinsulated pipe OD 88 - 103 mm	09601		09661		09676	
			for flexible preinsulated pipe OD 108 - 115 mm	09602		09662		09677	
			for flexible preinsulated pipe OD 119 - 128 mm	09603		09663		09678	
		for flexible preinsulated pipe OD 135 - 144 mm	09604		09664		09679		

double	Set 4 heating: double district heating baseplate penetration	Scope of delivery complete set Basic set <ul style="list-style-type: none"> • Baseplate penetration incl. wall collar, two casing pipes for flexible preinsulated pipes OD 90 mm up to 140 mm max. • One mounting stand: extendable tripod incl. fixing accessories for tripod • Two PVC-pipe bends • Protective endcaps Installation kit <ul style="list-style-type: none"> • Two kits of centering ring (system raci) • Two Pressio®-Rings seal Type FW 2x40 mm with oversized flange 							
		Basic set	Empty conduit system without sealing	09610	995,00	09665	1.245,00	09684	1.700,00
		Complete set (incl. installation kit)	for flexible preinsulated pipe 2x OD 69 - 78 mm	09615	1.445,00	09666	1.695,00	09685	2.150,00
			for flexible preinsulated pipe 2x OD 88 - 103 mm	09611		09667		09686	
			for flexible preinsulated pipe 2x OD 108 - 115 mm	09612		09668		09687	
			for flexible preinsulated pipe 2x OD 119 - 128 mm	09613		09669		09688	
		for flexible preinsulated pipe 2x OD 135 - 144 mm	09614		09670		09689		

Installation kit	for subsequent addition to the basic set**	Art.-No.	€/pcs.
	for flexible preinsulated pipe OD 69 - 78 mm	09625	275,00
	for flexible preinsulated pipe OD 88 - 103 mm	09621	
	for flexible preinsulated pipe OD 108 - 115 mm	09622	
	for flexible preinsulated pipe OD 119 - 128 mm	09623	
	for flexible preinsulated pipe OD 135 - 144 mm	09624	

* Oversized pallets, any free carriage limit does not apply here. Shipped as one unit per pallet, bulky freight.

** Für ein 2-fach Set werden 2 Installations-Sets benötigt

Accessories / spare parts		
Product group 300		
Wall collar for OD 200 mm incl. steel straps	12811	40,15
Product group 410		
PE endcap DN 200 - protective cover	13024	9,95
Product group 750		
Rubber Endseal AKT DN 200/150-0 mm incl. steel straps	18091	38,75

Fix-loose flange Pressio® wall penetration seals and wall sleeves



Product group 250

Non-pressing water

Description	outer diameter pipe mm	inner diameter sleeve/core-drilling mm	€/pcs.	rubber sheets* €/ 2 pcs.
Pressio® seal with fixed-loose flange against non-pressing water according to DIN 18533 (W1-E, W3-E) for buildings with sealing sheeting, incl. screws and dowels for mounting galvanised steel version	20 - 40	80	on request	on request
	15 - 65	100		
	55 - 78	125		
	46 - 110	150		
	88 - 160	200		
	135 - 210	250		
	178 - 226	300		
	224 - 282	350		
	270 - 330	400		
	300 - 400	500		
	400 - 500	600		
	500 - 600	700		
	600 - 700	800		
	700 - 800	900		
800 - 900	1000			



Other sizes and stainless steel S 304 or S 316 on request

Description	outer diameter pipe mm	inner diameter sleeve mm	sleeve length in mm €/pcs.		rubber sheets* €/ 2 pcs.
			250	350	
Wall sleeve with fixed-loose flange against non-pressing water according to DIN 18533 (W1-E, W3-E) for buildings with sealing sheeting galvanised steel version	20 - 40	80	on request	on request	on request
	15 - 65	100			
	55 - 78	125			
	46 - 110	150			
	88 - 160	200			
	135 - 210	250			
	178 - 226	300			
	224 - 282	350			
	270 - 330	400			
	300 - 400	500			
	400 - 500	600			
	500 - 600	700			
	600 - 700	800			
	700 - 800	900			
800 - 900	1000				



Others sizes and stainless steel S 304 or S 316 on request.

Description	outer diameter pipe mm	inner diameter sleeve mm	sleeve length 100 mm €/pcs.	rubber sheets* €/ 2 pcs.
On wall sleeve with fixed-loose flange against non-pressing water according to DIN 18533 (W1-E, W3-E) for buildings with sealing sheeting, incl. screws and dowels for mounting galvanised steel version	20 - 40	80	on request	on request
	15 - 65	100		
	55 - 78	125		
	46 - 110	150		
	88 - 160	200		
	135 - 210	250		
	178 - 226	300		
	224 - 282	350		
	270 - 330	400		
	300 - 400	500		
	400 - 500	600		
	500 - 600	700		
	600 - 700	800		
	700 - 800	900		
800 - 900	1000			



Others sizes and stainless steel S 304 or S 316 on request.

* Rubber sheets (flange-shaped sealing slices made from elastomer) for wall penetrations with fixed-loose flange, for pressing and non-pressing water. According to DIN 18533 rubber sheets are recommended for elastomeric sheeting material: PIP, EPDM, EVA, ECB. We also recommend them for PVC, PE and PE-HD.

Fix-loose flange Pressio® wall penetration seals and wall sleeves



Product group 250

Pressing Water

Description	outer diameter pipe mm	inner diameter sleeve/core-drilling mm	€/pcs.	rubber sheets* €/ 2 pcs.
Pressio® seal with fixed-loose flange against pressing water according to DIN 18533 (W2-E) for buildings with sealing sheeting, incl. screws and dowels for mounting galvanised steel version	20 - 40	80	on request	on request
	15 - 65	100		
	55 - 78	125		
	46 - 110	150		
	88 - 160	200		
	135 - 210	250		
	178 - 226	300		
	224 - 282	350		
	270 - 330	400		
	300 - 400	500		
	400 - 500	600		
	500 - 600	700		
	600 - 700	800		
	700 - 800	900		
800 - 900	1000			

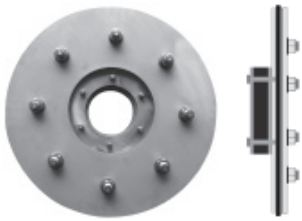

Others sizes and stainless steel S 304 or S 316 on request.

Description	outer diameter pipe mm	inner diameter sleeve mm	Sleeve length in mm €/pcs.		rubber sheets* €/ 2 pcs.
			250	350	
Wall sleeve with fixed-loose flange against pressing water according to DIN 18533 (W2-E) for buildings with sealing sheeting galvanised steel version	20 - 40	80	on request	on request	on request
	15 - 65	100			
	55 - 78	125			
	46 - 110	150			
	88 - 160	200			
	135 - 210	250			
	178 - 226	300			
	224 - 282	350			
	270 - 330	400			
	300 - 400	500			
	400 - 500	600			
	500 - 600	700			
	600 - 700	800			
	700 - 800	900			
800 - 900	1000				



Others sizes and stainless steel S 304 or S 316 on request.

Description	outer diameter pipe mm	inner diameter sleeve mm	sleeve length 100 mm €/pcs.	rubber sheets* €/ 2 pcs.
On wall sleeve with fixed-loose flange against pressing water according to DIN 18533 (W2-E) for buildings with sealing sheeting, incl. screws and dowels for mounting galvanised steel version	20 - 40	80	on request	on request
	15 - 65	100		
	55 - 78	125		
	46 - 110	150		
	88 - 160	200		
	135 - 210	250		
	178 - 226	300		
	224 - 282	350		
	270 - 330	400		
	300 - 400	500		
	400 - 500	600		
	500 - 600	700		
	600 - 700	800		
	700 - 800	900		
800 - 900	1000			

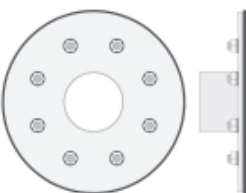

Others sizes and stainless steel S 304 or S 316 on request.

* Rubber sheets (flange-shaped sealing slices made from elastomer) for wall penetrations with fixed-loose flange, for pressing and non-pressing water. According to DIN 18533 rubber sheets are recommended for elastomeric sheeting material: PIP, EPDM, EVA, ECB. We also recommend them for PVC, PE and PE-HD.

Fix-loose flange Pressio® wall penetration seals and on wall sleeves 4 pipes

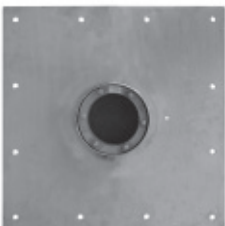

Product group 250

Description	OD pipe mm	ID sleeve mm	€/pcs.
on-wall sleeve, closed incl. screws, dowels and sealing adhesive galvanised steel version  Does not include Pressio seal	20 - 40	80	on request
	15 - 65	100	
	55 - 78	125	
	46 - 110	150	
	88 - 160	200	
	135 - 210	250	
	178 - 226	300	
	224 - 282	350	
	270 - 330	400	
	300 - 400	500	
	400 - 500	600	
	500 - 600	700	
	600 - 700	800	
	700 - 800	900	
800 - 900	1000		

Other sizes and stainless steel S 304 or S 316 on request

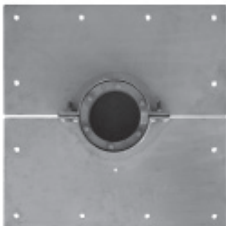
Description	OD pipe mm	ID sleeve mm	€/pcs.
on-wall sleeve, split incl. screws, dowels and sealing adhesive galvanised steel version  Does not include Pressio seal	20 - 40	80	on request
	15 - 65	100	
	55 - 78	125	
	46 - 110	150	
	88 - 160	200	
	135 - 210	250	
	178 - 226	300	
	224 - 282	350	
	270 - 330	400	
	300 - 400	500	
	400 - 500	600	
	500 - 600	700	
	600 - 700	800	
	700 - 800	900	
800 - 900	1000		

Others sizes and stainless steel S 304 or S 316 on request.

For drawings ordered by the customer we keep the option to charge an hourly fee up to 95,00 €

Pressio®-Elements wall penetration seal 4 pipes



Product group 100

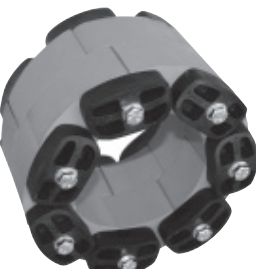

		Quality C, EPDM-Rubber Colour black, Shore 50 ± 5, bolts galvanised		Quality S316, EPDM-Rubber Colour black, Shore 50 ± 5, bolts stainless steel	
Description	Type	Art.-No.	€/pcs.	Art.-No.	€/pcs.
Wall penetration seal Pressio®-Elements:  (Standard EPDM - black)	IL 100	09999	2,40	10029	2,65
	IL 200	10000	2,45	10030	2,70
	IL 265	10001	4,05	10031	5,65
	IL 275	10002	3,45	10032	4,60
	IL 300	10003	4,90	10033	6,00
	IL 310	10004	5,60	10034	7,15
	IL 315	10005	5,60	10035	7,15
	IL 325	10006	8,20	10036	13,45
	IL 340	10007	7,55	10037	10,55
	IL 360	10008	9,35	10038	11,90
	IL 400	10009	13,45	10039	19,35
	IL 410	10010	10,90	10040	16,35
	IL 425	10011	12,50	10041	17,85
	IL 440	10012	15,25	10042	22,30
	IL 475	10013	11,90	10043	17,85
	IL 500	10014	23,80	10044	35,70
	IL 525	10015	23,25	10045	34,20
	IL 575	10016	20,15	10046	32,75
IL 650	10019	34,05	10049	48,85	

		Quality BC, EPDM-Rubber Colour blue, Shore 40 ± 5, bolts galvanised		Quality BS316, EPDM-Rubber Colour blue, Shore 40 ± 5, bolts stainless steel	
Description	Type	Art.-No.	€/pcs.	Art.-No.	€/pcs.
Wall penetration seal Pressio®-Elements:  (soft EPDM - blue)	IL 100	10059	2,55	10089	3,00
	IL 200	10060	2,65	10090	3,05
	IL 265	10061	4,55	10091	6,20
	IL 275	10062	3,75	10092	5,05
	IL 300	10063	5,30	10093	6,60
	IL 310	10064	6,15	10094	7,90
	IL 315	10065	6,15	10095	7,90
	IL 325	10066	9,05	10096	14,70
	IL 340	10067	8,35	10097	11,50
	IL 360	10068	10,35	10098	13,70
	IL 400	10069	15,30	10099	21,25
	IL 410	10070	12,05	10100	18,80
	IL 425	10071	14,00	10101	19,70
	IL 440	10072	16,85	10102	24,50
	IL 475	10073	13,10	10103	19,70
	IL 500	10074	27,40	10104	39,30
	IL 525	10075	26,50	10105	37,60
	IL 575	10076	21,95	10106	36,05
	IL 615	10077	46,70	10107	60,75
	IL 625	10078	31,10	10108	40,45
IL 650	10079	37,40	10109	53,70	
IL 700	10080	51,55	10110	66,75	

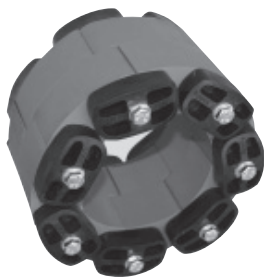

Product group 100

Description	Type	Quality O, Nitrile-Rubber Colour green, Shore 50 ± 5, bolts galvanised		Quality OS316, Nitrile-Rubber Colour green, Shore 50 ± 5, bolts stainless steel	
		Art.-No.	€/pcs.	Art.-No.	€/pcs.
Wall penetration seal Pressio®-Elements:  (Nitrile rubber - green)	IL 100	10119	2,90	10149	3,40
	IL 200	10120	2,95	10150	3,45
	IL 265	10121	4,90	10151	6,95
	IL 275	10122	4,05	10152	5,35
	IL 300	10123	5,80	10153	7,30
	IL 310	10124	6,70	10154	8,60
	IL 315	10125	6,70	10155	8,60
	IL 325	10126	9,85	10156	16,10
	IL 340	10127	8,95	10157	12,50
	IL 360	10128	11,25	10158	15,00
	IL 400	10129	16,80	10159	23,30
	IL 410	10130	13,10	10160	20,55
	IL 425	10131	15,20	10161	21,40
	IL 440	10132	18,25	10162	26,65
	IL 475	10133	14,85	10163	21,40
	IL 500	10134	30,00	10164	42,80
	IL 525	10135	28,85	10165	41,00
	IL 575	10136	24,05	10166	39,30
	IL 615	10137	55,85	10167	72,70
	IL 625	10138	37,25	10168	48,55
IL 650	10139	40,85	10169	58,55	
IL 700	10140	56,80	10170	73,40	

Description	Type	Quality TS, Silicone-Rubber Colour grey, bolts stainless steel, pressure plates V4A		Quality KTW/W270, EPDM-Rubber, Colour black, Shore 50 ± 5, pressure plates white	
		Art.-No.	€/pcs.	Art.-No.	€/pcs.
Wall penetration seal Pressio®-Elements: Quality TS for temperatures to 200°C  Quality KTW/W270 for contact with drinking water 	IL 100	01179	8,65	01210	4,75
	IL 200	01180	10,25	01211	5,80
	IL 265	01181	16,35	01212	7,65
	IL 275	01182	13,00	01213	6,20
	IL 300	01183	17,05	01214	9,10
	IL 310	01184	20,15	01215	12,05
	IL 315	01185	20,15	01216	10,25
	IL 325	01186	34,10	01217	16,90
	IL 340	01187	32,70	01218	13,85
	IL 360	01188	40,80	01219	15,90
	IL 400	01189	65,30	01220	31,80
	IL 410	01190	63,15	01221	26,85
	IL 425	01191	59,80	01222	27,75
	IL 440	01192	69,30	01223	41,15
	IL 475	01193	59,80	01224	28,00
	IL 500	01194	119,55	01225	66,35
	IL 525	01195	119,55	01226	56,95
	IL 575	01196	119,55	01227	47,60
	IL 615	01197	152,75	-	-
	IL 625	01198	101,90	01229	92,90
IL 650	01199	111,35	01230	76,75	
IL 700	01200	162,95	-	-	

Pressio®-Elements-Set 4 pipes



Product group 150



Pressio®-Elements-Set (EPDM blue) preassembled as a complete ring, delivered in a handy box.

sleeve/hole ID in mm	carrier pipe OD in mm		Quality BC, bolts galvanised		Quality BS316, bolts stainless steel	
	min.	max.	Art.-No.	€/Set	Art.-No.	€/Set
50	1	18	09000	34,55	09100	51,85
	18	25	09001	34,55	09101	51,85
80	22	27	09010	43,80	09110	65,65
	40	48	09011	43,80	09111	65,65
100	32	45	09020	48,85	09120	73,15
	48	57	09021	48,85	09121	73,15
	55	64	09022	48,85	09122	73,15
125	42	61	09030	65,10	09130	97,65
	57	74	09031	65,10	09131	97,65
	80	89	09032	65,10	09132	97,65
150	53	76	09040	75,75	09140	113,60
	66	78	09041	75,75	09141	113,60
	82	99	09042	75,75	09142	113,60
	105	115	09043	75,75	09143	113,60
200	84	104	09050	97,80	09150	156,45
	103	117	09051	97,80	09151	156,45
	116	133	09052	97,80	09152	156,45
	132	149	09053	97,80	09153	156,45
	148	157	09054	97,80	09154	156,45
	156	164	09055	97,80	09155	156,45
250	107	129	09060	124,45	09160	199,00
	134	154	09061	124,45	09161	199,00
	153	163	09062	124,45	09162	199,00
	158	177	09063	124,45	09163	199,00
	176	193	09064	124,45	09164	199,00
300	184	204	09070	187,30	09170	300,05
	203	217	09071	187,30	09171	300,05
	216	236	09072	187,30	09172	300,05
350	207	229	09080	224,40	09180	359,00
	234	254	09081	224,40	09181	359,00
	253	274	09082	224,40	09182	359,00
	266	286	09083	224,40	09183	359,00

Pressio®-Elements selection guide

for core drilled holes



Product group 100

 Sleeve/hole ID in mm	Carrier pipe OD in mm		Quantity of elements	Type IL...	€/ring			
	min.	max.			Quality C	Quality BC	Quality S316	Quality BS316
50	10	18	4	275	13,80	15,00	18,40	20,20
	25	32	4	100	9,60	10,20	10,60	12,00
70	30	36	6	275	20,70	22,50	27,60	30,30
	39	45	6	200	14,70	15,90	16,20	18,30
	45	52	6	100	14,40	15,30	15,90	18,00
80	40	48	8	275	27,60	30,00	36,80	40,40
	49	55	7	200	17,15	18,55	18,90	21,35
	55	62	7	100	16,80	17,85	18,55	21,00
100	32	45	5	340	37,75	41,75	52,75	57,50
	48	57	6	315	33,60	36,90	42,90	47,40
	55	64	6	300	29,40	31,80	36,00	39,60
	62	68	6	265	24,30	27,30	33,90	37,20
	68	75	9	200	22,05	23,85	24,30	27,45
	75	82	9	100	21,60	22,95	23,85	27,00
125	42	61	5	360	46,75	51,75	59,50	68,50
	58	74	7	340	52,85	58,45	73,85	80,50
	73	82	8	315	44,80	49,20	57,20	63,20
	80	89	8	300	39,20	42,40	48,00	52,80
	87	93	8	265	32,40	36,40	45,20	49,60
	95	100	12	200	29,40	31,80	32,40	36,60
	100	107	12	100	28,80	30,60	31,80	36,00
150	58	76	5	410	54,50	60,25	81,75	94,00
	66	82	6	360	56,10	62,10	71,40	82,20
	82	99	9	340	67,95	75,15	94,95	103,50
	105	114	7	310	39,20	43,05	50,05	55,30
	112	118	10	265	40,50	45,50	56,50	62,00
	118	125	14	200	34,30	37,10	37,80	42,70
	125	132	14	100	33,60	35,70	37,10	42,00
200	90	104	6	575	120,90	131,70	196,50	216,30
	103	117	7	475	83,30	91,70	124,95	137,90
	103	124	7	410	76,30	84,35	114,45	131,60
	116	133	9	360	84,15	93,15	107,10	123,30
	132	149	13	340	98,15	108,55	137,15	149,50
	155	164	10	310	56,00	61,50	71,50	79,00
250	134	154	8	575	161,20	175,60	262,00	288,40
	140	160	6	440	91,50	101,10	133,80	147,00
	153	163	9	475	107,10	117,90	160,65	177,30
	158	177	7	400	94,15	107,10	135,45	148,75
	166	186	12	360	112,20	124,20	142,80	164,40
	178	192	7	425	87,50	98,00	124,95	137,90
	190	203	9	325	73,80	81,45	121,05	132,30
	206	212	12	310	67,20	73,80	85,80	94,80
300	157	173	7	500	166,60	191,80	249,90	275,10
	184	204	10	575	201,50	219,50	327,50	360,50
	190	210	8	440	122,00	134,80	178,40	196,00
	208	226	12	410	130,80	144,60	196,20	225,60
	216	236	15	360	140,25	155,25	178,50	205,50
	234	244	20	340	151,00	167,00	211,00	230,00
	240	253	11	325	90,20	99,55	147,95	161,70
	255	264	15	310	84,00	92,25	107,25	118,50

Pressio®-Elements selection guide for core drilled holes



Product group 100

 Sleeve/hole ID in mm	Carrier pipe OD in mm		Quantity of elements	Type IL...	€/ring			
	min.	max.			Quality C	Quality BC	Quality S316	Quality BS316
350	182	210	8	650	272,40	299,20	390,80	429,60
	207	229	9	500	214,20	246,60	321,30	353,70
	223	239	9	525	209,25	238,50	307,80	338,40
	234	254	12	575	241,80	263,40	393,00	432,60
	253	267	14	475	166,60	183,40	249,90	275,80
	253	274	14	410	152,60	168,70	228,90	263,20
	266	286	18	360	168,30	186,30	214,20	246,60
	258	274	10	400	134,50	153,00	193,50	212,50
	276	293	11	425	137,50	154,00	196,35	216,70
	286	296	24	340	181,20	200,40	253,20	276,00
	294	303	13	325	106,60	117,65	174,85	191,10
307	314	18	310	100,80	110,70	128,70	142,20	
400	204	234	9	625	-	279,90	-	364,05
	234	255	9	650	306,45	336,60	439,65	483,30
	264	279	10	500	238,00	274,00	357,00	393,00
	273	289	11	525	255,75	291,50	376,20	413,60
	284	304	14	575	282,10	307,30	458,50	504,70
	292	310	11	440	167,75	185,35	245,30	269,50
	303	317	16	475	190,40	209,60	285,60	315,20
	308	327	12	400	161,40	183,60	232,20	255,00
	326	341	12	425	150,00	168,00	214,20	236,40
340	353	15	325	123,00	135,75	201,75	220,50	
450	235	256	7	700	-	360,85	-	467,25
	254	265	10	625	-	311,00	-	404,50
	266	286	7	615	-	326,90	-	425,25
	285	311	11	650	374,55	411,40	537,35	590,70
	307	329	12	500	285,60	328,80	428,40	471,60
	327	339	12	525	279,00	318,00	410,40	451,20
	335	354	16	575	322,40	351,20	524,00	576,80
	345	356	13	440	198,25	219,05	289,90	318,50
	355	367	19	475	226,10	248,90	339,15	374,30
	358	377	14	400	188,30	214,20	270,90	297,50
	376	393	14	425	175,00	196,00	249,90	275,80
	375	386	24	360	224,40	248,40	285,60	328,80
	390	403	17	325	139,40	153,85	228,65	249,90
500	285	306	8	700	-	412,40	-	534,00
	304	334	12	625	-	373,20	-	485,40
	335	359	12	650	408,60	448,80	586,20	644,40
	357	379	14	500	333,20	383,60	499,80	550,20
	373	389	14	525	325,50	371,00	478,80	526,40
	385	400	18	575	362,70	395,10	589,50	648,90
	390	410	14	440	213,50	235,90	312,20	343,00
	408	427	15	400	201,75	229,50	290,25	318,75
	426	443	16	425	200,00	224,00	285,60	315,20
	440	453	19	325	155,80	171,95	255,55	279,30

Pressio®-Elements selection guide for core drilled holes



Product group 100

 Sleeve/hole ID in mm	Carrier pipe OD in mm		Quantity of elements	Type IL...	€/ring			
	min.	max.			Quality C	Quality BC	Quality S316	Quality BS316
600	385	406	10	700	-	515,50	-	667,50
	404	434	15	625	-	466,50	-	606,75
	436	457	15	650	510,75	561,00	732,75	805,50
	457	479	17	500	404,60	465,80	606,90	668,10
	473	489	17	525	395,25	450,50	581,40	639,20
	490	503	17	440	259,25	286,45	379,10	416,50
	503	509	25	475	297,50	327,50	446,25	492,50
	508	527	19	400	255,55	290,70	367,65	403,75
	526	543	19	425	237,50	266,00	339,15	374,30
	540	553	23	325	188,60	208,15	309,35	338,10

Available qualities:	
Qualität C	Rubber EPDM (black standard), bolts galvanised
Qualität BC	Rubber EPDM (blue, extra soft for PE pipe), bolts galvanised
Qualität S316	Rubber EPDM (black), bolts stainless steel
Qualität BS316	Rubber EPDM (blue, extra soft for PE pipe), bolts stainless steel
Qualität OC	Rubber Nitrile (green, oil resistant), bolts galvanised, Price on request
Qualität OS316	Rubber Nitrile (green, oil resistant), bolts stainless steel, Price on request
Qualität TS	Rubber Silicone (grey, high temperature resistant), bolts stainless steel, pressure plates stainless steel, Price on request
Qualität KTW/W270	Rubber EPDM (black, accord. to KTW/W270 / UBA-BWLG), bolts stainless steel, pressure plates white, Price on request

Manhole connectors 4 pipes



Product group 330

Manhole connector P-MC	Pipe OD mm	drilled hole Ø in mm	Art.-No.	€/pcs.
	110	138	22900	14,65
	125	151	22901	15,60
	160	186	22902	18,30
	200	226	22903	21,40
	250	276	22904	27,55
	315	341	22905	33,85
	400	426	22906	42,20
	500	526	22907	52,10
	630	656	22908	64,80

Product group 410

Rubber support ring	ID or wall sleeve	Ø Carrier pipe in mm	Art.-No.	€/pcs.
	DI 70	18-32	13040	3,95
	DI 70	40	13039	3,95
	DI 80	25-42	13041	4,20
	DI 80	45-52	13042	4,20
	DI 90	25-42	13043	4,35
	DI 90	42-54	13044	4,35
	DI 99-103,6	20-25	13045	4,65
	DI 99-103,6	32-40	13046	4,65
	DI 99-103,6	40-56	13047	4,65
	DI 99-103,6	56-66	13048	4,65

Conical sealing plug, sealing compound 4 pipes





Product group 410

Description	For Casing ID Ø in mm	For Carrier Pipe OD Ø in mm	Fits Flexible Casing pipe DN/OD	Artikel-No.	€/pcs.
	37 - 43	Blind*	50 / 50	12940	4,80
		32		12941	3,65
	45 - 55	Blind*	63 / 64	12945	5,95
		32		12946	4,95
		40		12947	4,95
	54 - 64	Blind*	75 / 76	12950	7,20
		32		12951	5,65
		40		12952	5,65
		50		12953	5,65
	62 - 72	Blind*		12955	8,10
		32		12956	6,45
		40		12957	6,45
		50		12958	6,45
	70 - 80	Blind*	90 / 91	12960	8,95
		32		12961	6,85
		40		12962	6,85
		50		12963	6,85
		63		12964	6,85
		32 + 12* *Ø32 and Ø12 prepared with blind plugs		12965	13,70
	85 - 95	Blind*	110 / 111	12970	12,90
		32		12971	11,05
		40		12972	11,05
		50		12973	11,05
		63		12974	11,05
	96 - 106	Blind*	120 / 118	12980	15,30
		32		12981	13,70
		40		12982	13,70
		50		12983	13,70
63		12984		13,70	
32 + 2x7* *2x Ø7 prepared with blind plugs		12986		16,45	
40* + 1x12* *Ø40 and Ø12 prepared with blind plugs		12987		19,70	

** Number and possible size of drilled holes on request. 8,00 EUR per hole.

Product group 225 – Stopaq sealing compound 4 pipes

	Description	Type	packing unit	Art.-No.	€/pcs.
	Sealing compound for wall penetration permanently elastic	Stopaq FN 2100 cartridge 0,33 kg		25	11100
Stopaq FN 2100 cartridge 0,53 kg			20	11101	67,15
	Accessories				
	Grouting tool* for 0,33 kg cartridge	for 310 ml	1	11103	35,30*
	Grouting tool* for 0,53 kg cartridge	for 600 ml	1	11104	135,50*
	Foam tape, roll à 5 m	-	15	11105	13,60
	Stopaq cement, 0,5 kg	for 2100	20	11106	22,60

* No discount on tools

Aqua Stopper pipeline closure plugs 4 pipes



Product group 375

Aluminium Edition					
					
Sealing range					
Min. pipe ID in mm	Max. pipe ID in mm	Max. Water pressure* in bar	Thread size (inch)	Art.-No.	€/pcs.
38	50	1,5	1/2	13930	37,70
49	62	1,5	1/2	13931	39,45
62	77	1,5	1/2	13932	46,55
73	89	1	1/2	13933	50,20
84	103	1	1/2	13934	53,65
94	110	0,5	1/2	13935	62,80
112	130	0,5	1/2	13936	71,95
125	142	0,5	1/2	13937	78,50
146	168	0,5	1/2	13938	87,85
175	200	0,5	1	13939	232,85
193	220	0,5	1	13940	246,50
220	240	0,5	1	13941	252,90
245	270	0,5	1	13942	278,15
277	328	0,5	1	13943	292,30
295	325	0,5	1	13944	306,15
325	360	0,3	1	13945	464,05
350	385	0,3	1	13946	490,60
370	410	0,3	1	13947	502,80
390	435	0,3	1	13948	519,40
445	495	0,3	2	13949	577,95
495	550	0,2	2	13950	644,80
595	650	0,2	2	13951	902,80

*with additional holding fixture

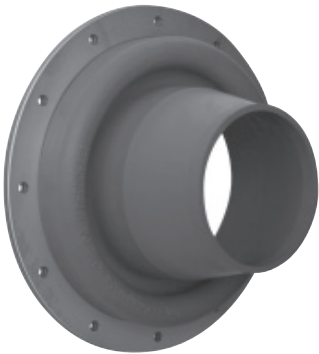

Product group 850

Description	Pipe OD in mm	max. core drilled hole Ø in mm	OD wall flange in mm	Art.-No.	€/pcs.
 <p>Compensating seal for wall penetrations of moving or settling pipelines. Pressure tight up to 1,0 bar Expansion ± 40 mm possible Prices incl. stainless steel fastening straps, screws, dowels and special adhesive.</p>	KMR OD 75-90-110	150 / 200	350	20050	407,80
	KMR OD 125-140-160	200 / 250	400	20051	504,20
	KMR OD 180-200-225	300	450	20052	668,20
	KMR OD 250-280-315	350 / 400	565	20053	837,75
	KMR OD 355-400	450 / 500	650	20054	1.014,30
	KMR OD 450-500	550 / 600	750	20055	1.270,65
	KMR OD 560-630	650 / 700	880	20056	1.680,35
	KMR OD 670	800	950	20058	1.942,00
	KMR OD 710-800	800 / 900	1050	20057	2.295,05

Other dimensions on request.

Hex Head screws M12 mm DIN 571 – Dowels 14 mm – Thickness of seal 8 mm ± 1 mm

Casing seal type KMR 4 pipes



Product group 800

Art.-No.	Description	€/pcs.
19810	Casing seal 4 pipes Type KMR OD 75 x DN 100	193,55
19811	Casing seal 4 pipes Type KMR OD 75 x DN 125	200,25
19812	Casing seal 4 pipes Type KMR OD 75 x DN 150	226,90
19813	Casing seal 4 pipes Type KMR OD 75 x DN 200	247,00
19819	Casing seal 4 pipes Type KMR OD 90 x DN 150	226,90
19820	Casing seal 4 pipes Type KMR OD 90 x DN 200	264,35
19821	Casing seal 4 pipes Type KMR OD 90 x DN 250	280,35
19824	Casing seal 4 pipes Type KMR OD 110 x DN 150	233,70
19825	Casing seal 4 pipes Type KMR OD 110 x DN 200	268,30
19826	Casing seal 4 pipes Type KMR OD 110 x DN 250	319,00
19829	Casing seal 4 pipes Type KMR OD 125 x DN 150	247,00
19830	Casing seal 4 pipes Type KMR OD 125 x DN 200	274,35
19831	Casing seal 4 pipes Type KMR OD 125 x DN 250	320,35
19799	Casing seal 4 pipes Type KMR OD 140 x DN 200	280,35
19832	Casing seal 4 pipes Type KMR OD 140 x DN 250	323,05
19833	Casing seal 4 pipes Type KMR OD 140 x DN 300	379,05
19834	Casing seal 4 pipes Type KMR OD 160 x DN 200	313,70
19835	Casing seal 4 pipes Type KMR OD 160 x DN 250	327,00
19836	Casing seal 4 pipes Type KMR OD 160 x DN 300	375,10
19839	Casing seal 4 pipes Type KMR OD 200 x DN 250	429,75
19840	Casing seal 4 pipes Type KMR OD 200 x DN 300	437,80
19841	Casing seal 4 pipes Type KMR OD 200 x DN 350	469,80
19842	Casing seal 4 pipes Type KMR OD 225 x DN 300	437,80
19843	Casing seal 4 pipes Type KMR OD 225 x DN 400	536,45
19844	Casing seal 4 pipes Type KMR OD 250 x DN 300	480,50
19845	Casing seal 4 pipes Type KMR OD 250 x DN 350	491,20
19846	Casing seal 4 pipes Type KMR OD 250 x DN 400	541,90
19849	Casing seal 4 pipes Type KMR OD 315 x DN 350	553,85
19850	Casing seal 4 pipes Type KMR OD 315 x DN 400	560,45
19851	Casing seal 4 pipes Type KMR OD 315 x DN 450	651,35
19855	Casing seal 4 pipes Type KMR OD 355 x DN 450	605,65
19856	Casing seal 4 pipes Type KMR OD 355 x DN 500	660,65
19859	Casing seal 4 pipes Type KMR OD 400 x DN 450	652,95
19860	Casing seal 4 pipes Type KMR OD 400 x DN 500	660,65
19861	Casing seal 4 pipes Type KMR OD 400 x DN 550	727,35
19864	Casing seal 4 pipes Type KMR OD 450 x DN 500	655,35
19865	Casing seal 4 pipes Type KMR OD 450 x DN 550	736,65
19866	Casing seal 4 pipes Type KMR OD 450 x DN 600	907,50
19870	Casing seal 4 pipes Type KMR OD 500 x DN 600	847,45
19871	Casing seal 4 pipes Type KMR OD 500 x DN 650	904,80
19875	Casing seal 4 pipes Type KMR OD 560 x DN 650	899,50
19876	Casing seal 4 pipes Type KMR OD 560 x DN 700	960,85
19880	Casing seal 4 pipes Type KMR OD 630 x DN 700	954,15
19881	Casing seal 4 pipes Type KMR OD 630 x DN 750	1.002,25
19885	Casing seal 4 pipes Type KMR OD 670 x DN 750	976,85
19886	Casing seal 4 pipes Type KMR OD 670 x DN 800	1.065,00
19890	Casing seal 4 pipes Type KMR OD 710 x DN 800	1.083,55
19891	Casing seal 4 pipes Type KMR OD 710 x DN 850	1.133,05
19900	Casing seal 4 pipes Type KMR OD 800 x DN 900	1.243,75
19901	Casing seal 4 pipes Type KMR OD 800 x DN 950	1.285,10
19910	Casing seal 4 pipes Type KMR OD 900 x DN 1000	1.403,80
19911	Casing seal 4 pipes Type KMR OD 900 x DN 1050	1.407,85
19920	Casing seal 4 pipes Type KMR OD 1000 x DN1100	1.483,95
19921	Casing seal 4 pipes Type KMR OD 1000 x DN1150	1.534,60
19927	Casing seal 4 pipes Type KMR OD 1100 x DN1200	1.617,35
19928	Casing seal 4 pipes Type KMR OD 1200 x DN1300	1.854,85



Casing seal pressure tight up to 1,0 bar.
Set including sealing compound and stainless steel straps.

Other sizes on request.

Not a stock item, made to order.

Custom made flanged sealing sleeve in closed or split version, only on request.



A pressure tightness of 1,0 bar can be reached up to an annular space of 75 mm

Wall collars 4 pipes



Product group 300

Wall collar	Material: rubber	OD Pipe in mm	Range		packing unit	Art.-No.	€/pcs.
			from pipe-OD	to pipe-OD			
		20/25	18	25	100	12838	27,15
		32	29	32	90	12800	27,15
		40	38	42	90	12801	27,15
		50	48	53	70	12802	27,15
		63	60	64	70	12803	28,05
		75	71	80	50	12804	30,65
		90	84	92	40	12805	32,05
		100	95	105	30	12839	33,55
		110	108	116	25	12806	34,65
		125	120	130	20	12807	37,20
		140	135	148	20	12808	37,90
		160	154	166	15	12809	38,15
		170	166	171	12	12850	38,65
		180	175	190	12	12810	39,45
		200	195	210	10	12811	40,15
		225	215	230	10	12812	41,50
		250	245	260	10	12813	42,45
		280	273	290	10	12814	44,40
		315	310	327	10	12815	56,20
		355	350	365	10	12816	76,25
		400	395	410	10	12817	85,25
		450	440	460	10	12818	89,65
		500	495	515	10	12819	100,25
		560	555	580	10	12820	109,60
	630	625	650	-	12821	120,15	
	710	705	735	-	12822	132,35	
	800	795	830	-	12823	146,75	
	900	895	930	-	12824	175,55	
	1000	995	1030	-	12825	206,20	
	1200	1195	1240	-	12826	243,30	
	1400	1395	1450	-	12827	259,00	

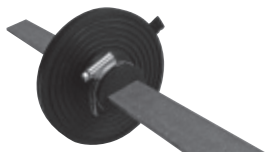
Wall collar for Flash Protection	OD Pipe in mm	Range		packing unit	Art.-No.	€/pcs.
		from pipe-OD	to pipe-OD			
	8	7	10	-	12835	23,45
	12	10	14	-	12836	23,45
	30x3	30x2	30x5	-	12837	23,45



Price incl. stainless steel fixing bands



Double wall collar XL	OD Pipe in mm		Art.-No.	€/pcs.
	25	77	12770	20,00
	32	84	12771	20,95
	40	92	12772	23,75
	50	102	12773	27,15
	63	115	12774	28,95
	75	127	12775	30,65
	90	142	12776	32,10
	100	152	12777	33,55
	110	162	12778	34,65
	125	177	12779	37,20
	140	192	12781	38,05
	150	202	12782	38,15
	160	212	12783	38,15
	175	227	12784	38,65
	200	252	12785	40,15
	225	277	12786	41,15
250	302	12787	42,45	
315	367	12788	59,95	





KG Wall- and baseplate pipe bushings 4 pipes

Product group 415

Baseplate pipe bushing 4 pipes		Pipe OD mm	Art.-No.	€/pcs.
	Pipe KG2000 (PP-green)	DN 110	27728	54,15
		DN 125	27729	63,50
		DN 160	27730	77,75
		DN 200	27731	119,90
	Pipe KG (PVC-orange)	DN 110	27732	43,05
		DN 125	27733	47,60
		DN 160	27734	53,80
		DN 200	27735	73,60

Baseplate pipe bushing 4 pipes incl. self-adhesive flange		Pipe OD mm	Glue-on flange size	Art.-No.	€/pcs.
	Pipe KG2000 (PP-green)	DN 110	330 x 330	27745	88,25
		DN 125	350 x 350	27746	100,25
		DN 160	400 x 400	27747	119,70
		DN 200	500 x 500	27748	169,70
	Pipe KG (PVC-orange)	DN 110	330 x 330	27749	77,15
		DN 125	350 x 350	27750	84,35
		DN 160	400 x 400	27751	95,75
		DN 200	500 x 500	27752	123,45

Wall pipe bushing 4 pipes		Pipe OD mm	possible length	Art.-No.	€/pcs.
	Pipe KG2000 (PP-green)	DN 110	150 – 560 mm	27704	98,35
		DN 125	150 – 560 mm	27705	108,85
		DN 160	220 – 580 mm	27706	126,30
		DN 200	240 – 600 mm	27707	171,00
	Pipe KG (PVC-orange)	DN 110	150 – 560 mm	27708	87,25
		DN 125	150 – 560 mm	27709	93,10
		DN 160	220 – 580 mm	27710	102,30
		DN 200	240 – 600 mm	27711	124,55

Supplied incl. endcap and preassembled double wall-collar, tight against pressing water.

On request:



Wall pipe bushing with bell on both sides



Wall pipe bushing made of HT-PP-pipe grey



Wall sleeves 4 pipes fibre cement

Product group 400



ID sleeve	Length 200 mm		Length 240 mm		Length 250 mm		Length 300 mm		Length 350 mm	
	Art.-No.	€/pcs.	Art.-No.	€/pcs.	Art.-No.	€/pcs.	Art.-No.	€/pcs.	Art.-No.	€/pcs.
80	13100	22,90	13486	25,70	13101	25,70	13102	29,35	13103	40,65
100	13112	37,85	13297	41,60	13113	41,60	13114	47,20	13115	56,10
125	13124	41,60	13298	49,25	13125	49,25	13126	53,00	13127	61,60
150	13136	45,50	13299	52,95	13137	52,95	13138	56,80	13139	69,65
200	13148	56,85	13481	66,10	13149	66,10	13150	68,05	13151	83,55
250	13160	73,80	13487	86,85	13161	86,85	13162	92,55	13163	104,25
300	13172	81,25	13483	92,55	13173	92,55	13174	109,40	13175	124,75
350	13184	99,80	13488	113,20	13185	113,20	13186	126,45	13187	149,75
400	13196	106,05	13485	123,00	13197	123,00	13198	140,05	13199	169,70
500	13220	167,05	*	*	13221	214,90	13222	214,90	13223	264,00
600	13232	193,95	*	*	13233	255,45	13234	255,45	13235	315,95
700	13244	214,90	*	*	13245	296,85	13246	323,60	13247	364,20
800	13256	240,10	*	*	13257	348,40	13258	389,05	13259	413,45

ID sleeve	Length 365 mm		Length 400 mm		Length 450 mm		Length 500 mm		Length 600 mm	
	Art.-No.	€/pcs.	Art.-No.	€/pcs.	Art.-No.	€/pcs.	Art.-No.	€/pcs.	Art.-No.	€/pcs.
80	13489	41,60	13104	41,60	13105	48,85	13106	49,85	13107	60,75
100	13490	56,80	13116	56,80	13117	67,25	13118	68,05	13119	78,20
125	13491	62,40	13128	62,40	13129	71,65	13130	72,40	13131	82,70
150	13480	70,55	13140	70,55	13141	92,95	13142	93,90	13143	106,55
200	13482	84,30	13152	84,30	13153	95,90	13154	97,05	13155	110,95
250	13288	105,25	13164	105,25	13165	113,85	13166	115,10	13167	128,40
300	13484	126,45	13176	126,45	13177	138,15	13178	140,00	13179	153,45
350	13492	153,00	13188	153,00	13189	175,90	13190	179,60	13191	193,90
400	13493	174,00	13200	174,00	13201	188,75	13202	201,55	13203	219,80
500	*	*	13224	264,00	13225	297,55	13226	310,85	13227	338,20
600	*	*	13236	315,95	13237	348,50	13238	376,30	13239	411,10
700	*	*	13248	383,80	13249	426,80	13250	467,05	13251	534,35
800	*	*	13260	451,10	13261	504,75	13262	558,20	13263	660,10

ID sleeve	Length 700 mm		Length 800 mm		Length 1000 mm		Length 1200 mm		Length 1500 mm	
	Art.-No.	€/pcs.	Art.-No.	€/pcs.	Art.-No.	€/pcs.	Art.-No.	€/pcs.	Art.-No.	€/pcs.
80	13108	70,15	13109	81,30	-	-	-	-	-	-
100	13120	88,90	13121	99,65	13122	120,75	13123	140,90	13275	176,10
125	13132	92,95	13133	103,55	13134	123,90	13135	144,20	13276	180,20
150	13144	120,00	13145	133,05	13146	158,00	13147	186,10	13290	232,60
200	13156	125,80	13157	137,65	13158	162,50	13159	190,65	13291	238,30
250	13168	141,55	13169	153,30	13170	182,15	13171	208,30	13289	260,40
300	13180	166,60	13181	180,80	13182	205,10	13183	233,65	13269	292,05
350	13192	203,10	13193	222,70	13194	261,05	13195	301,30	13296	376,65
400	13204	248,95	13205	280,35	13206	340,60	13207	400,85	13293	501,05
500	13228	364,90	13229	393,35	13230**	448,05	-	-	-	-
600	13240	444,40	13241	478,15	13242**	531,85	-	-	-	-
700	13252	582,15	13253	625,55	13254**	675,80	-	-	-	-
800	13264	713,80	13265	768,90	13266**	819,90	-	-	-	-

*on request **max. Length L=960 ±20 mm tolerance

Other sizes on request.

Wall sleeves 4 pipes fibre cement split version



Product group 400



ID sleeve	Length 200 mm		Length 240 mm		Length 250 mm		Length 300 mm		Length 350 mm	
	Art.-No.	€/pcs.	Art.-No.	€/pcs.	Art.-No.	€/pcs.	Art.-No.	€/pcs.	Art.-No.	€/pcs.
100	13312	68,15	13592	74,90	13313	74,90	13314	85,00	13315	101,00
125	13324	74,90	13593	88,65	13325	88,65	13326	95,40	13327	110,90
150	13336	81,90	13594	95,35	13337	95,35	13338	102,25	13339	125,40
200	13348	102,35	13595	119,00	13349	119,00	13350	122,50	13351	150,40
250	13360	132,85	13596	156,35	13361	156,35	13362	166,60	13363	187,65
300	13372	146,25	13597	166,60	13373	166,60	13374	196,95	13375	224,55
350	13384	179,65	*	*	13385	203,80	13386	227,65	13387	269,55
400	13396	190,90	*	*	13397	221,40	13398	252,10	13399	305,50
500	13420	300,70	*	*	13421	386,85	13422	386,85	13423	475,20
600	13432	349,15	*	*	13433	459,85	13434	459,85	13435	568,75
700	13444	386,85	*	*	13445	534,35	13446	582,50	13447	655,60
800	13456	432,20	*	*	13457	627,15	13458	700,30	13459	744,25

ID sleeve	Length 365 mm		Length 400 mm		Length 450 mm		Length 500 mm		Length 600 mm	
	Art.-No.	€/pcs.	Art.-No.	€/pcs.	Art.-No.	€/pcs.	Art.-No.	€/pcs.	Art.-No.	€/pcs.
100	13478	102,25	13316	102,25	13317	121,05	13318	122,50	13319	140,80
125	13479	112,35	13328	112,35	13329	129,00	13330	130,35	13331	148,90
150	13494	127,00	13340	127,00	13341	167,35	13342	169,05	13343	191,80
200	13495	151,75	13352	151,75	13353	172,65	13354	174,70	13355	199,75
250	13598	189,45	13364	189,45	13365	204,95	13366	207,20	13367	231,15
300	13599	227,65	13376	227,65	13377	248,70	13378	252,00	13379	276,25
350	*	*	13388	275,40	13389	316,65	13390	323,30	13391	349,05
400	*	*	13400	313,20	13401	339,75	13402	362,80	13403	395,65
500	*	*	13424	475,20	13425	535,60	13426	559,55	13427	608,80
600	*	*	13436	568,75	13437	627,30	13438	677,35	13439	740,00
700	*	*	13448	690,85	13449	768,25	13450	840,70	13451	961,85
800	*	*	13460	812,00	13461	908,55	13462	1.004,80	13463	1.188,20

ID sleeve	Length 700 mm		Length 800 mm		Length 1000 mm		Length 1200 mm		Length 1500 mm	
	Art.-No.	€/pcs.	Art.-No.	€/pcs.	Art.-No.	€/pcs.	Art.-No.	€/pcs.	Art.-No.	€/pcs.
100	13320	160,05	13321	179,40	13322	217,35	13323	253,65	13470	317,00
125	13332	167,35	13333	186,40	13334	223,05	13335	259,60	13471	324,40
150	13344	216,00	13345	239,50	13346	284,40	13347	335,00	13472	418,70
200	13356	226,45	13357	247,80	13358	292,50	13359	343,20	13473	428,95
250	13368	254,80	13369	275,95	13370	327,90	13371	374,95	13474	468,75
300	13380	299,90	13381	325,45	13382	369,20	13383	420,60	13475	525,70
350	13392	365,60	13393	400,90	13394	469,90	13395	542,35	13476	678,00
400	13404	448,15	13405	504,65	13406	613,10	13407	721,55	13477	901,90
500	13428	656,85	13429	708,05	13430**	806,50	-	-	-	-
600	13440	799,95	13441	860,70	13442**	957,35	-	-	-	-
700	13452	1.047,90	13453	1.126,00	13454**	1.216,45	-	-	-	-
800	13464	1.284,85	13465	1.384,05	13466**	1.475,85	-	-	-	-

*on request

**max. Length L=960 ±20 mm tolerance

*** A surcharge for dangerous goods is coming on top of transport costs for split wall sleeves.

Prices incl. epoxy adhesive for joining half-shells.

No stock item!

Additional sizes on request.

Wall sleeves/shaft linings PVC 4 pipes

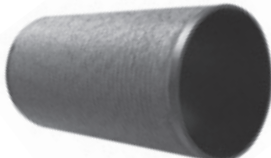

Product group 410

Description	ID in mm	OD in mm	Length in mm*	Art.-No.	€/pcs.
PVC Wall Sleeve 	50	54	400	13000	10,25
	60	64	400	13001	11,20
	70	75	400	13002	12,15
	70	75	2000**	13058	54,35
	80	85	400	13003	13,40
	80	85	2000**	13019	60,10
	90	95	400	13004	14,40
	100	106	400	13005	15,60
	125	131	400	13007	30,10
	125	131	3000**	13066	105,45
	150	160	400	13008	40,95
	150	160	3000**	13065	152,95
	200	210	400	13009	51,40
	200	210	1500	13061	148,95
	increased wall thickness	300	315	400	13013
300		315	1000	13064	192,40
100		110	400	13006	21,80
100		110	3000**	13018	106,45
250		280	400	13010	211,00
250	280	1000	13062	365,40	

*other length on request

**Attention bulky goods freight surcharge for lengths ≥ 2 m

Description	ID in mm	OD in mm	OD bonding flange in mm	Length in mm*	Art.-No.	€/pcs.
PVC Wall Sleeve with bonding flange 	80	85	185	400	13873	81,65
	100	110	210	400	13876	97,70
	125	131	231	400	13877	91,15
	150	160	260	400	13878	107,65
	200	210	310	400	13879	138,10
	250	280	380	400	13880	280,60
	300	315	415	400	13881	195,55

*other length on request

Wall sleeve with formed bell and seal	ID in mm	OD Bell in mm	Length in mm	Art.-No.	€/pcs.
	100	110	500	13011	54,00



Wall sleeve Mounting Cap PE 	Ø ID PVC wall sleeve in mm		Art.-No.	€/pcs.
	80		13020	4,00
	100		13021	4,45
	125		13022	6,05
	150		13023	8,10
	200		13024	9,95
	250		13025	12,15
300		13026	14,60	

Shaft linings PVC  with internal lip seal for pushing in the medium pipe	for pipe OD in mm		Length in mm	Art.-No.	€/pcs.
	110		110	13030	on request
	110		250	13032	on request
	110		300	13035	on request
	125		110	13038	on request
	125		250	13033	on request
	125		300	13036	on request
	160		110	13031	on request
	160		250	13034	on request
160		300	13037	on request	

Epoxy resin for core drilled holes, Wall sleeves steel and H2 Detection Tape 4 pipes



Product group 400

 <p>Drinking water KTW/W270</p>	Description	Unit	Art.-No.	€/pcs
	Epoxy resin for conservation of core drilled holes 2 components	1,0 kg unit	13099	86,05
	1K Beto-coat paint for conservation of core drilled holes	750 ml can	13096	53,80

Product group 420

Steel wall sleeve with middle collar circular 50 mm height, fully welded from both sides.

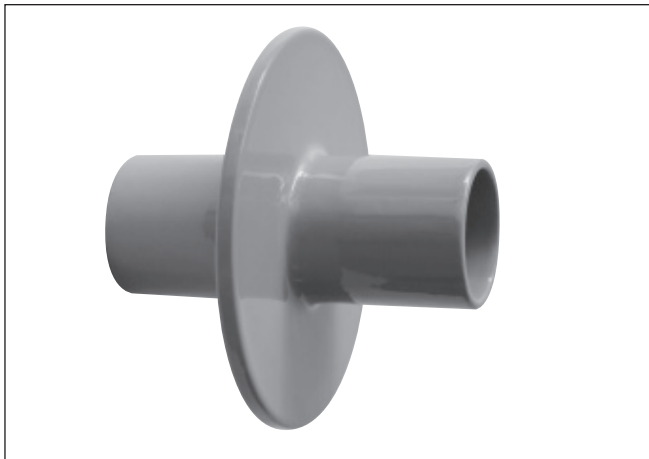

Steel wall sleeves bright black, galvanised or made of stainless steel on request.

All sleeves are made to order, please consider respective delivery period.

Rubber-steel flange gasket type RSG for steel and cast iron flanges



Product group 425 up to and including DN 300; Product group 450 from size DN 350 and larger

DN		Dimensions in mm EN 1514-1 ISO 7483	Pressure Rate PN					Art.-No.	Rubber Nitrile* €/pcs.	Art.-No.	Rubber EPDM- KTW** €/pcs.	Art.-No.	Rubber FKM €/pcs.
			6	10	16	25	40						
15		22 x 51 x 4		x	x	x	x	13500	3,75	13600	3,75	13700	9,30
20		27 x 61 x 4		x	x	x	x	13501	3,85	13601	3,85	13701	10,05
25		34 x 71 x 4		x	x	x	x	13502	4,65	13602	4,65	13702	10,55
32	43 x 76 x 4		x					13503	4,80	13603	4,80	13703	11,80
	43 x 82 x 4			x	x	x	x	13504	4,80	13604	4,80	13704	14,00
40		49 x 92 x 4		x	x	x	x	13505	5,05	13605	5,05	13705	16,85
50	61 x 96 x 5		x					13506	5,45	13606	5,45	13706	31,25
	61 x 107 x 5			x	x	x	x	13507	5,45	13607	5,45	13707	31,25
65	77 x 116 x 5		x					13508	5,60	13608	5,60	13708	33,45
	77 x 127 x 5			x	x	x	x	13509	5,60	13609	5,60	13709	33,45
80	89 x 132 x 5		x					13582	5,70	13682	5,70	13782	34,70
	89 x 142 x 4			x	x	x	x	13510	5,70	13610	5,70	13710	42,70
100	115 x 152 x 6		x					13511	6,35	13611	6,35	13711	55,20
	115 x 162 x 5			x	x			13512	6,35	13612	6,35	13712	55,20
	115 x 168 x 6					x	x	13513	6,40	13613	6,40	13713	59,55
125	141 x 182 x 6		x					13514	7,40	13614	7,40	13714	65,30
	141 x 192 x 5			x	x			13515	7,40	13615	7,40	13715	65,30
	141 x 194 x 6					x	x	13516	7,60	13616	7,60	13716	66,45
150	169 x 207 x 7		x					13517	8,80	13617	8,80	13717	84,80
	169 x 218 x 5			x	x			13518	8,95	13618	8,95	13718	84,80
	169 x 224 x 7					x	x	13519	9,35	13619	9,35	13719	92,20
200	220 x 262 x 7		x					13520	10,00	13620	10,00	13720	114,35
	220 x 273 x 6			x	x			13521	11,90	13621	11,90	13721	114,35
	220 x 284 x 7					x		13522	12,40	13622	12,40	13722	115,20
	220 x 290 x 7						x	13523	14,20	13623	14,20	13723	118,80
250	273 x 317 x 7		x					13524	13,55	13624	13,55	13724	122,85
	273 x 328 x 6			x				13525	13,55	13625	13,55	13725	128,55
	273 x 329 x 7				x			13526	13,65	13626	13,65	13726	128,55
	273 x 340 x 7					x		13527	14,20	13627	14,20	13727	129,65
	273 x 352 x 7						x	13528	14,55	13628	14,55	13728	134,70
300	324 x 373 x 6		x					13529	17,40	13629	17,40	13729	151,55
	324 x 378 x 6			x				13530	17,50	13630	17,50	13730	151,55
	324 x 384 x 7				x			13531	18,00	13631	18,00	13731	161,20
	324 x 400 x 7					x		13532	19,30	13632	19,30	13732	187,40
	324 x 417 x 7						x	13533	21,25	13633	21,25	13733	199,05
350	356 x 423 x 7		x					13534	19,60	13634	19,60	13734	207,30
	356 x 438 x 7			x				13535	19,85	13635	19,85	13735	207,30
	356 x 444 x 7				x			13536	20,15	13636	20,15	13736	213,55
	356 x 457 x 7					x		13537	20,50	13637	20,50	13737	216,45
	356 x 474 x 7						x	13538	22,55	13638	22,55	13738	217,10





* Nitrile Gas approval DVGW

** according to DVGW W270, Elastomer Guideline of the UBA/KTW DVGW-Confirmation of conformity hygiene, WRAS and ACS
Further sizes, pressure rates and sealings on request

Rubber-steel flange gasket type RSG for steel and cast iron flanges



Product group 425 up to and including DN 300; Product group 450 from size DN 350 and larger

												
DN	Dimensions in mm EN 1514-1 ISO 7483	Pressure Rate PN					Art.-No.	Rubber Nitrile* €/pcs.	Art.-No.	Rubber EPDM- KTW** €/pcs.	Art.-No.	Rubber FKM €/pcs.
		6	10	16	25	40						
400	407 x 473 x 7	x					13539	21,95	13639	21,95	13739	232,75
	407 x 489 x 7		x				13540	23,10	13640	23,10	13740	232,75
	407 x 495 x 7			x			13541	23,50	13641	23,50	13741	236,55
	407 x 514 x 7				x		13542	23,90	13642	23,90	13742	237,55
	407 x 546 x 7					x	13543	24,80	13643	24,80	13743	249,35
450	458 x 539 x 7		x				13545	23,90	13645	23,90	13745	260,50
500	508 x 578 x 7	x					13549	38,65	13649	38,65	13749	353,75
	508 x 594 x 7		x				13550	38,95	13650	38,95	13750	372,50
	508 x 617 x 7			x			13551	40,90	13651	40,90	13751	374,75
	508 x 624 x 7				x		13552	40,90	13652	40,90	13752	374,90
	508 x 628 x 7					x	13580	46,15	13680	46,15	13780	402,50
600	610 x 679 x 7	x					13553	44,70	13653	44,70	13753	486,20
	610 x 695 x 7		x				13554	47,35	13654	47,35	13754	486,20
	610 x 734 x 7			x			13555	47,60	13655	47,60	13755	547,90
	610 x 731 x 7				x		13556	49,60	13656	49,60	13756	556,55
	610 x 747 x 7					x	13581	52,70	13681	52,70	13781	568,20
700	712 x 784 x 8	x					13557	63,40	13657	63,40	13757	577,60
	712 x 810 x 8		x				13558	65,05	13658	65,05	13758	577,60
	712 x 804 x 8			x			13559	65,05	13659	65,05	13759	582,15
	712 x 833 x 8				x		13560	69,50	13660	69,50	13760	582,15
800	813 x 890 x 8	x					13561	91,50	13661	91,50	13761	596,45
	813 x 917 x 8		x				13562	93,50	13662	93,50	13762	634,60
	813 x 911 x 8			x			13563	98,10	13663	98,10	13763	638,40
	813 x 942 x 8				x		13564	104,20	13664	104,20	13764	644,80
900	915 x 990 x 8	x					13565	108,40	13665	108,40	-	-
	915 x 1017 x 8		x				13566	110,05	13666	110,05	-	-
	915 x 1011 x 8			x			13567	111,15	13667	111,15	-	-
	915 x 1042 x 8				x		13568	112,95	13668	112,95	-	-
1000	1016 x 1090 x 8	x					13569	114,95	13669	114,95	-	-
	1016 x 1124 x 8		x				13570	115,80	13670	115,80	-	-
	1016 x 1128 x 8			x			13571	136,35	13671	136,35	-	-
	1020 x 1154 x 8				x		13572	149,95	13672	149,95	-	-
1100	1120 x 1231 x 8		x			13585	219,00	13685	219,00	-	-	
1200	1220 x 1307 x 8	x					13573	320,10	13673	320,10	-	-
	1220 x 1341 x 8		x	x			13574	322,20	13674	322,20	-	-
	1220 x 1364 x 8				x		13575	331,00	13675	331,00	-	-
1400	1420 x 1548 x 8		x			13576	400,50	13676	400,50	-	-	
1600***	1620 x 1772 x 8		x			-	-	13677	441,85	-	-	
1800***	1820 x 1972 x 8		x			-	-	13678	564,25	-	-	
2000***	2020 x 2182 x 8		x			-	-	13679	627,50	-	-	

* Nitrile Gas approval DVGW

** according to DVGW W270, Elastomer Guideline of the UBA/KTW
DVGW-Confirmation of conformity hygiene, WRAS and ACS

*** Attention! RSG ≥ DN 1600 delivery ex works only - bulky freight





Delivery Rubber Steel Gaskets Type RSG from incl.
DN 1200: ex works

Further sizes, pressure rates and sealings on request

Rubber flange gasket type RSG-TW-K, RSG-G-K, RSG-FKM-K for plastic flanges

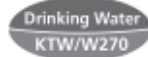

Product group 425 up to DA 315 mm, Product group 450 from size DA 355 mm and larger



 Rubber-steel flange seals type RSG-TW-K are suitable for PE / PP / PVC / PVDF pressure pipelines (SDR), flanges connections with plastic pre-welded collars, loose flanges and flange similar to DIN 16962-4 (PP)/ DIN 16963-4 (PE)/ DIN EN 1092-1 (DIN 2501 PN 10/16)					 RSG-G-K		 RSG-TW-K		 RSG-FKM-K	
OD Pipe in mm	SDR	Similar to DIN EN 1092-1 DIN 2501	Similar to DIN 16962 Teil 4 DIN 16963 Teil 4	Dimensions in mm	Art.-No.	Rubber Nitrile* €/pcs.	Art.-No.	Rubber EPDM-KTW** €/pcs.	Art.-No.	Rubber FKM-K €/pcs.
10		x		16 x 46 x 4	27548	3,90	27648	3,90	27448	11,65
20		x		20 x 51 x 4	27500	4,55	27600	4,55	27400	12,00
25	11	x	x	22 x 61 x 4	27501	5,10	27601	5,10	27401	14,40
32	11	x	x	28 x 71 x 4	27502	6,00	27602	6,00	27402	19,60
40	11		x	34 x 82 x 4	27503	7,25	27603	7,25	27403	26,35
		x		40 x 82 x 4	27504	6,40	27604	6,40	27404	26,75
50	17	x	x	46 x 92 x 4	27505	7,40	27605	7,40	27405	27,90
	11	x	x	42 x 92 x 4	27506	7,70	27606	7,70	27406	29,55
63	17	x	x	58 x 107 x 5	27507	9,90	27607	9,90	27407	33,50
	11	x	x	53 x 107 x 5	27508	10,10	27608	10,10	27408	35,90
75	17	x	x	69 x 127 x 5	27509	10,50	27609	10,50	27409	45,90
	11	x	x	63 x 127 x 5	27510	10,80	27610	10,80	27410	47,80
90	17	x	x	84 x 142 x 5	27511	10,95	27611	10,95	27411	48,65
	11	x	x	76 x 142 x 5	27512	11,15	27612	11,15	27412	55,05
110	33	x	x	104 x 162 x 6	27513	11,15	27613	11,15	27413	65,75
	17	x	x	100 x 162 x 6	27514	11,30	27614	11,30	27414	71,65
	11	x	x	93 x 162 x 6	27515	11,60	27615	11,60	27415	77,65
125	33	x	x	123 x 162 x 6	27516	10,40	27616	10,40	27416	78,55
	17	x	x	114 x 162 x 6	27517	10,50	27617	10,50	27417	80,20
	11	x	x	105 x 162 x 6	27518	11,15	27618	11,15	27418	96,45
140	33	x	x	137 x 192 x 5	27519	15,00	27619	15,00	27419	102,15
	17	x	x	127 x 192 x 6	27520	15,55	27620	15,55	27420	118,80
	11	x	x	117 x 192 x 6	27521	16,20	27621	16,20	27421	125,80
160	17	x	x	146 x 218 x 8	27522	16,50	27622	16,50	27422	149,90
	11		x	135 x 218 x 8	27523	17,30	27623	17,30	27423	160,30
		x			160 x 218 x 8	27524	15,75	27624	15,75	27424
180	17		x	164 x 218 x 8	27525	15,85	27625	15,85	27425	172,30
	11		x	151 x 218 x 8	27526	16,15	27626	16,15	27426	186,00
200	17	x	x	181 x 273 x 8	27527	22,50	27627	22,50	27427	207,05
	11		x	168 x 273 x 8	27528	24,20	27628	24,20	27428	222,90
225	17	x	x	203 x 273 x 8	27529	20,50	27629	20,50	27429	238,10
	11		x	188 x 273 x 8	27530	22,60	27630	22,60	27430	245,65
250	17		x	226 x 328 x 8	27531	32,30	27631	32,30	27431	262,70
	11		x	208 x 328 x 8	27532	33,85	27632	33,85	27432	302,50
280	17	x	x	252 x 328 x 8	27533	30,70	27633	30,70	27433	302,65
	11		x	233 x 328 x 8	27534	32,35	27634	32,35	27434	302,90
315	33	x	x	306 x 378 x 8	27535	34,40	27635	34,40	27435	303,40
	17		x	283 x 378 x 8	27536	34,50	27636	34,50	27436	303,60
	11		x	262 x 378 x 8	27537	38,85	27637	38,85	27437	303,95
355	17		x	319 x 438 x 8	27538	49,45	27638	49,45	27438	304,50
	11		x	294 x 438 x 8	27539	52,25	27639	52,25	27439	316,70
400		x		400 x 489 x 8	27540	53,65	27640	53,65	27440	359,45
	17		x	359 x 489 x 8	27541	54,00	27641	54,00	27441	388,10
	11		x	331 x 489 x 8	27542	58,50	27642	58,50	27442	407,65
450	17	x	x	403 x 594 x 10	27543	87,10	27643	87,10	27443	670,35
	11		x	372 x 594 x 10	27544	98,00	27644	98,00	27444	708,65
500	17	x	x	447 x 594 x 10	27545	83,70	27645	83,70	27445	712,80
560	17	x	x	494 x 695 x 10	27546	107,45	27646	107,45	27446	807,70
630	17	x	x	555 x 695 x 10	27547	102,85	27647	102,85	27447	810,15

*Also available in Nitrile to EN682 **according to DVGW W270, Elastomer Guideline of UBA/KTW DVGW-Confirmation of conformity hygiene, WRAS, ACS

Rubber flange gasket type RSG for ANSI flange



Product group 425 up to size 12", Product group 450 from size 14" and larger

 Rubber flange gasket type RSG for ANSI flange flat design					 DIN DVGW product		 Drinking Water KTW/W270	
Inch	Class LBS	ID mm	OD mm	Thickness	Art.-No.	Rubber Nitrile* €/pcs.	Art.-No.	Rubber EPDM** €/pcs.
1/2"	150	18,0	45,5	3	29300	4,70	29400	4,70
3/4"	150	27,5	53,5	3	29301	4,75	29401	4,75
1"	150	34,0	63,5	3	29302	5,80	29402	5,80
1"	300	34,0	70,5	3	29303	5,85	29403	5,85
1 1/4"	150	42,5	74,0	3	29304	6,05	29404	6,05
1 1/2"	150	48,5	84,0	3	29305	6,30	29405	6,30
2"	150	60,0	102,0	4	29306	6,75	29406	6,75
2"	300	60,5	107,5	4	29307	6,80	29407	6,80
2 1/2"	150	73,0	121,0	4	29308	7,05	29408	7,05
3"	150	89,0	133,0	4	29309	7,20	29409	7,20
3 1/2"	150	102,0	159,0	4	29310	7,65	29410	7,65
4"	150	115,0	172,0	4	29311	7,95	29411	7,95
5"	150	141,0	193,0	5	29312	9,25	29412	9,25
6"	150	168,5	219,0	5	29313	11,20	29413	11,20
8"	150	219,0	277,0	6	29314	14,85	29414	14,85
10"	150	273,0	337,0	6	29315	23,80	29415	23,80
12"	150	324,0	407,0	6	29316	27,10	29416	27,10
14"	150	356,0	448,0	7	29317	32,30	29417	32,30
16"	150	406,5	513,0	7	29318	35,15	29418	35,15
18"	150	457,0	547,0	7	29319	37,25	29419	37,25
20"	150	508,0	604,0	7	29320	42,05	29420	42,05
22"	150	560,0	658,0	7	29321	48,10	29421	48,10
24"	150	610,0	715,0	7	29322	52,30	29422	52,30

*Also available in Nitrile to EN682

**according to DVGW W270, Elastomer Guideline of UBA/KTW DVGW-Confirmation of conformity hygiene, WRAS, ACS FKM on request

Rubber flange gasket type RFG



Product group 425 up to size DN 300, Product group 450 from size DN 350 and larger



flexible, without insert, EPDM

DN	suitable for PN	Dimensions in mm	Art.-No.	EPDM €/pcs.
32	6/10/16	40 x 71,5 x 3	13850	1,80
40	6/10/16	50 x 83 x 3	13851	1,80
50	6/10/16	60 x 97 x 3	13852	1,95
65	6/10/16	75 x 121 x 3	13853	2,25
80	6/10/16	80 x 130 x 3	13854	2,60
100	6/10/16	100 x 154 x 3	13855	3,15
125	6/10/16	125 x 183 x 3	13856	3,65
150	6/10/16	150 x 209 x 3	13857	4,25
175	6/10/16	175 x 223 x 4	13858	5,65
200	6/10/16	200 x 263 x 3	13859	5,65
250	6/10/16	250 x 313 x 4	13860	6,85
300	6/10/16	300 x 364 x 4	13861	9,20
350	6/10/16	350 x 425 x 4	13862	16,35
400	6/10/16	400 x 476 x 4	13863	18,25
450	6/10/16	450 x 545 x 4	13864	20,30
500	6/10/16	500 x 576 x 5	13865	23,75
600	6/10/16	600 x 676 x 5	13866	31,30
700	6/10/16	700 x 790 x 6	13867	46,25
800	6/10/16	800 x 890 x 6	13868	59,00
900	6/10/16	900 x 990 x 6	13869	68,95

Rubber-steel flange gasket type RSG-TW-V 4 pipes



Product group 450

Adjustable rubber steel gasket type RSG-TW-V

Drinking Water
KTW/W270

Description	Nominal size	Pressure rate	Dimensions	Thickness		Bolts		Art.-No.	€/pcs.
	DN	PN		min.	max.	Length mm	Größe*		
 <p>Rubber Flange Gasket Type RSG-TW-V adjustable up to 8° Material: EPDM</p>	50	10 - 40	61x107	9	24	100	M 14	13802	38,35
	65	10 - 40	77x127	9	26	100	M 14	13803	41,60
	80	10 - 40	89x142	14	30	100	M 14	13804	45,90
	100	10 - 16	115x162	14	33	100	M 14	13805	53,25
	100	25 - 40	115x168	14	33	110	M 18	13806	59,35
	125	10 - 16	141x192	14	33	110	M 14	13807	59,40
	150	10 - 16	169x218	14	39	110	M 18	13808	62,45
	150	25 - 40	169x224	14	39	130	M 18	13809	68,75
	200	10 - 16	220x273	15	50	120	M 18	13810	77,95
	200	40	220x290	15	50	160	M 24	13811	94,95
	250	10 - 16	273x328	16	59	140	M 18	13812	113,85
	300	10	324x378	22	68	150	M 18	13814	193,60
	350	10	356x438	22	68	150	M 18	13815	262,40
	400	10	407x489	22	74	160	M 22	13816	323,55
500	10	508x594	23	79	180	M 22	13817	407,50	

Dimensions of 4 pipes Rubber Steel Gaskets Type RSG-TW-V according to DIN EN 1514-1, in mm

* We recommend using a smaller screw dimension

Combi-Seal-TW flange isolation gaskets 4 pipes



Product group 475

DN	Pressure rating PN				Art.-No.	€/pcs.
	10	16	25	40		
DN 25	x	x	x	x	14000	48,05
DN 32	x	x	x	x	14001	50,20
DN 40	x	x	x	x	14002	51,30
DN 50	x	x	x	x	14003	52,15
DN 65	x	x	x	x	14004	60,20
DN 80	x	x	x	x	14005	72,00
DN 100	x	x			14006	80,00
			x	x	14007	95,85
DN 125	x	x			14008	104,10
			x	x	14009	115,85
DN 150	x	x			14010	120,00
			x	x	14011	151,20
DN 200	x	x			14012	148,05
			x		14052	148,05
			x		14013	187,55
			x		14014	211,50
DN 250	x	x			14015	183,60
			x		14016	183,60
			x		14017	259,35
			x		14018	287,25
DN 300	x	x			14019	252,80
			x		14053	252,80
			x		14020	303,20
			x		14021	338,95
DN 350	x	x			14022	536,55
			x		14023	590,35
			x		14024	644,05
			x		14025	697,75
DN 400	x	x			14026	645,25
			x		14027	763,50
			x		14028	832,85
			x		14029	902,15
DN 500	x	x			14030	953,65
			x		14031	1.049,00
			x		14032	1.144,20
			x		14033	1.149,85
DN 600	x	x			14034	1.373,30
			x		14035	1.510,55
			x		14036	1.648,00
			x		14037	1.857,20
DN 700	x	x			14038	1.685,05
			x		14039	1.853,40
			x		14040	2.021,90
DN 800	x	x			14041	1.841,85
			x		14042	2.026,05
			x		14043	2.210,25
DN 900	x	x			14044	2.417,65
			x		14045	2.659,50
			x		14046	2.900,95
DN 1000	x	x			14047	2.912,90
			x		14048	3.212,25
			x		14049	3.503,95
DN 1200	x	x			14050	3.176,20
			x		14051	3.534,00

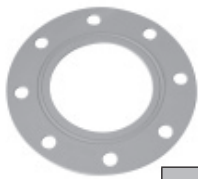

Combi-Seal-TW type E Only

Isolating gasket for potable water with KTW/W270 approval

Retainer: PVC white (Thickness 4 mm ≤ DN 250, 6 mm ≥ DN 300)

Sealing element: Silicone seal

Temperature: max. 80°C



Type E: Isolating gasket with screw holes
 Price for Type F (Isolating gaskets without bolt holes): - 3%
 Only: Isolating gasket without isolating kit
 Screw isolating kit needs to be ordered separately

Flange Isolations are produced accord. DIN 2632, 2633, 2634, 2635, 2636 (etc. on customers spec.) Production according other norms on request.
 For drawings ordered by the customer we reserve the right to charge an hourly fee up to 95,00 €

Combi-Seal-G flange isolation gaskets 4 pipes



Product group 475

DN	Pressure rating PN					Art.-No.	€/pcs.
	10	16	25	40	63		
25	x	x	x	x		14100	73,70
					x	14101	111,80
32	x	x	x	x		14102	91,80
					x	14103	139,25
40	x	x	x	x		14104	97,75
					x	14105	153,35
50	x	x	x	x		14106	120,60
					x	14107	183,30
65	x	x	x	x		14108	135,75
					x	14109	206,05
80	x	x	x	x		14110	183,25
					x	14111	270,40
100	x	x				14112	198,30
			x	x		14113	254,60
					x	14114	301,05
125	x	x				14115	205,50
			x	x		14116	314,70
					x	14117	319,40
150	x	x				14118	298,90
			x	x		14119	371,05
					x	14120	438,80
200	x					14121	521,30
		x				14162	521,30
			x			14122	551,85
				x		14123	613,80
					x	14124	652,45
250	x					14125	543,30
		x				14126	594,20
			x			14127	629,35
				x		14128	698,80
					x	14129	744,05
300	x					14130	597,40
		x				14131	725,35
			x			14132	768,20
				x		14133	854,00
					x	14134	906,25
350	x					14135	692,25
		x				14136	888,80
			x			14137	941,15
				x		14138	1.046,60
					x	14139	1.112,60

Combi-Seal-G with 20 mm retainer thickness available on request as custom made solution

Type E: Isolating gasket with screw holes

Price for Type F (Isolating gaskets without bolt holes): - 3%

Only: Isolating gasket without isolating kit

Screw isolating kit needs to be ordered separately

Flange Isolations are produced accord. DIN 2632, 2633, 2634, 2635, 2636 (etc. on customers spec.)



Production according other norms on request.

For drawings ordered by the customer we reserve the right to charge an hourly fee up to 95,00 €.

Combi-Seal-G flange isolation gaskets 4 pipes



Product group 475

	Combi-Seal-G type E Only Isolating gasket with DVGW-Gas- and „TA-Luft“ approval Retainer: G10 epoxy laminate (thickness 4 mm) Sealing element: graphite seal Temperature max.: 150°C						
	Pressure rating PN						Art.-No.
DN	10	16	25	40	63		
400	x					14140	944,65
		x				14141	1.146,90
			x			14142	1.214,40
				x		14143	1.350,60
					x	14144	1.435,50
500	x					14145	1.290,50
		x				14146	1.574,40
			x			14147	1.672,00
				x		14148	1.859,70
600	x					14149	1.872,90
		x				14150	2.274,90
			x			14151	2.408,05
700	x					14152	2.298,05
		x				14153	2.790,40
			x			14154	2.964,80
800	x					14155	2.512,15
		x				14156	3.050,20
			x			14157	3.229,75
900	x					14158	3.347,60
		x				14159	3.731,05
			x			14160	4.239,25

Combi-Seal-G with 20 mm retainer thickness available on request as custom made solution

Type E: Isolating gasket with screw holes

Price for Type F (Isolating gaskets without bolt holes): - 3%

Only: Isolating gasket without isolating kit

Screw isolating kit needs to be ordered separately

Flange Isolations are produced accord. DIN 2632, 2633, 2634, 2635, 2636 (etc. on customers spec.)

Production according other norms on request.

For drawings ordered by the customer we reserve the right to charge an hourly fee up to 95,00 €.

Combi-Seal-G200 flange isolation gaskets 4 pipes



Product group 475

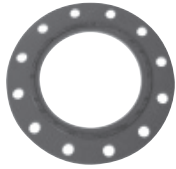

Combi-Seal-G200 type E Only

Isolating gasket with DVGW-Gas- and „TA-Luft“ approval

Retainer: G10 epoxy laminate (thickness 4 mm)

Sealing element: graphite seal

Isolating gasket for hot water and steam applications for up to 200°C and PN 100



DN	PN10	PN16	PN25	PN40	PN63	PN100
	€/pcs.	€/pcs.	€/pcs.	€/pcs.	€/pcs.	€/pcs.
25	136,95	136,95	136,95	136,95	182,15	208,30
32	170,35	170,35	170,35	170,35	226,70	255,55
40	184,95	184,95	184,95	184,95	246,00	277,65
50	224,25	224,25	224,25	224,25	298,40	336,25
65	252,40	252,40	252,40	252,40	335,60	378,55
80	331,40	331,40	331,40	331,40	440,65	497,00
100	368,85	368,85	374,50	374,50	490,50	553,15
125	382,65	382,65	459,10	459,10	505,45	573,85
150	537,65	537,65	645,15	645,15	715,00	806,45
200	799,60	879,55	959,45	1.039,45	1.063,45	1.199,35
250	911,90	1.003,15	1.094,30	1.185,50	1.212,85	1.367,85
300	1.112,85	1.224,10	1.335,50	1.446,70	1.479,90	1.669,20
350	1.363,80	1.500,20	1.636,60	1.772,90	1.813,80	
400	1.759,85	1.935,75	2.111,65	2.287,65	2.340,45	
500	2.423,10	2.665,40	2.907,55	3.150,00		
600	3.489,85	3.838,85	4.187,70			
700	4.281,95	4.710,10	5.138,25			
800	4.680,75	5.148,75	5.616,80			
900	5.051,35	5.306,50	5.210,10			

Type E: Isolating gasket with screw holes

Price for Type F (Isolating gaskets without bolt holes): - 3%

Only: Isolating gasket without isolating kit

Screw isolating kit needs to be ordered separately

Flange Isolations are produced accord. DIN 2632, 2633, 2634, 2635, 2636 (etc. on customers spec.)

Production according other norms on request.

For drawings ordered by the customer we reserve the right to charge an hourly fee up to 95,00 €.

Flange screw isolation-KIT (standard) individually prepared



Product group 480

For Combi-Seal-G / Combi-Seal-TW and Combi-Seal G200 isolating gaskets

Per flange we supply the right number of isolating components.
Per screw two isolating washers, two steel washers and one isolating sleeve are supplied.

*Isolating sleeve: Mylar (standard)
Isolating washer: G10 (standard)
Steel washer: galvanised DIN 126 (standard)

Size DN	PN 10	PN 16	PN 25	PN 40	PN 63	PN 100
	€/Kit	€/Kit	€/Kit	€/Kit	€/Kit	€/Kit
25	14,05	14,05	14,45	14,45	17,60	17,60
32	15,70	15,70	16,20	16,20	20,05	20,05
40	15,70	15,70	16,20	16,20	20,05	20,05
50	16,20	16,20	16,50	16,50	20,05	25,10
65	32,35	32,35	34,30	34,30	41,20	51,60
80	32,80	32,80	34,75	34,75	43,30	54,15
100	32,80	32,80	45,30	45,30	63,15	78,95
125	33,65	33,65	59,00	59,00	81,70	102,15
150	40,25	40,25	60,20	60,20	94,20	117,85
200	41,20	61,70	90,55	122,20	169,50	211,90
250	63,25	83,60	120,35	143,20	173,85	217,35
300	63,25	90,70	162,90	196,30	240,10	300,10
350	93,00	130,10	184,05	223,85	277,25	346,65
400	124,45	152,45	213,65	266,45	330,10	412,65
450	159,05	208,90	279,75	343,20	-	-
500	159,05	226,05	284,05	405,40	-	-
600	186,90	267,05	351,15	-	-	-
700	235,30	320,40	461,15	-	-	-
800	276,05	375,05	673,20	-	-	-
900	322,00	459,80	802,40	-	-	-
1000	382,75	574,10	1.140,00	-	-	-
1200	550,95	1.019,95	-	-	-	-

Other sizes, norms, pressure ratings on request.

*Isolating sleeves are made acc. to DIN 2632, 2633, 2634, 2635, 2636 depending on Pressure rating.

Production according other norms on request

Surcharges for special isolating kits	
Stainless steel washers S316Ti	Standard-Kit + 100 %
Isolating washers G11	Standard-Kit + 50 %
Isolating sleeves Nomex	Standard-Kit + 60 %

Isolating Bolts on request



Screw bolts with a laminated isolating epoxy resin glass fiber coating. A bolt contains two isolating washers, two steel washers DIN 126 and two nuts.

Bolts can be made from various Quality classes as well as sizes are manufactured according to customer specifications.

Flange screw isolation accessories



Product group 480



Mylar isolating sleeve - tubes length 1 meter each

Temperature range: -60°C up to +150°C, wall thickness 0,6 mm

Isolating Screw sizes	Art.-No.	€ per m
M 10	14460	12,00
M 12	14461	13,60
M 16	14462	14,55
M 20	14463	17,35
M 24	14464	24,55
M 27	14465	26,50
M 30	14466	28,15
M 33	14467	30,40
M 36	14468	32,80
M 39	14469	34,00
M 45	14470	44,95
M 52	14471	on request

Special cut lengths on request. Isolating sleeve for other temperature ranges (Nomex up to 220°C) on request. Other sizes on request.



G10 isolating washer

Temperature range: -60°C up to +130°C
Thickness: 3 mm

Isolating Screw sizes	Art.-No.	packing unit	€ per 100 pcs.
M 10	14430	100	53,10
M 12	14431	100	60,60
M 16	14432	100	67,40
M 20	14433	100	74,15
M 24	14434	100	114,40
M 27	14435	100	121,10
M 30	14436	100	141,30
M 33	14437	100	168,15
M 36	14438	100	255,55
M 39	14439	100	320,15
M 45	14440	100	605,65
M 52	14441	100	on request

Isolating washer for other temperature ranges (G11 up to 180°C) on request. Other sizes on request. **Supply in full units only.**



Steel washer galvanised DIN 126

Isolating Screw sizes	Art.-No.	packing unit	€ per 100 pcs.
M 10	14400	100	7,60
M 12	14401	100	8,90
M 16	14402	100	11,65
M 20	14403	100	17,30
M 24	14404	100	32,85
M 27	14405	100	42,45
M 30	14406	100	57,20
M 33	14407	100	87,40
M 36	14408	100	175,10
M 39	14409	100	192,95
M 45	14410	100	346,00
M 52	14411	100	on request

Other sizes, qualities on request. **Supply in full units only.**



Steel washer stainless steel V4A DIN 126

Isolating Screw sizes	Art.-No.	packing unit	€ per 100 pcs.
M 10	14412	100	on request
M 12	14413	100	on request
M 16	14414	100	on request
M 20	14415	100	on request
M 24	14416	100	on request
M 27	14417	100	on request
M 30	14418	100	on request
M 33	14419	100	on request
M 36	14420	100	on request
M 39	14421	100	on request
M 45	14422	100	on request
M 52	14423	100	on request

Other sizes, qualities on request. **Supply in full units only.**



Cable Duct Fitting 4 pipes

Product group 890

 <p>Cable Duct Fitting 4 pipes</p>			
pipe DN in mm	packaging unit	Art.-No.	€/pcs.
40	25	20602	5,95
50	15	20603	6,50
63	12	20604	13,50











 <p>Coupling with closed endcap 4 pipes</p>			
pipe DN in mm		Art.-No.	€/pcs.
40		20612	4,35
50		20613	5,50
63		20614	9,05

 <p>Coupling with Test Vent 4 pipes</p>			
pipe DN in mm		Art.-No.	€/pcs.
40		20622	22,25
50		20623	25,65
63		20624	27,15

Cleaning pigs 4 pipes



Product group 950

		Pigs: Super Soft yellow		Pigs: Medium Density blue					Pigs: Hard Density red		
											
		PM-S	PM-SX	PM-M	PM-MX	PM-MV	PM-MXB	PM-MXC	PM-H	PM-HX	PM-HV
Inch	DN	€/pcs.	€/pcs.	€/pcs.	€/pcs.	€/pcs.	€/pcs.	€/pcs.	€/pcs.	€/pcs.	€/pcs.
2,0	50	18,10	64,65	41,30	86,10	73,75	126,40	153,25	42,10	89,50	76,80
2,5	65	-	-	43,00	89,40	75,20	130,55	155,30	44,75	93,05	78,30
3,0	80	22,35	69,95	48,85	93,20	79,75	160,95	168,85	50,75	96,90	88,20
4,0	100	30,45	82,00	56,00	109,10	95,50	182,95	186,85	62,15	113,55	99,30
5,0	125	35,35	115,05	74,25	153,35	116,20	202,50	202,35	78,30	159,50	120,85
6,0	150	41,80	122,70	83,75	163,35	157,55	252,20	239,70	87,20	169,90	163,85
7,0	175	-	-	120,50	232,20	193,65	350,20	326,80	126,45	241,60	210,80
8,0	200	57,30	189,50	139,50	252,40	204,60	389,60	349,00	134,45	262,50	212,80
10,0	250	82,95	276,30	225,15	368,20	296,95	603,10	530,90	235,65	382,95	308,85
12,0	300	139,80	404,95	330,80	539,70	392,20	780,75	705,40	337,75	561,35	408,05
14,0	350	180,95	501,50	434,10	668,65	538,05	958,00	869,95	441,05	695,55	559,65
16,0	400	258,10	646,90	628,45	862,45	723,45	1.294,95	1.087,40	621,15	897,10	752,40
18,0	450	333,00	738,95	717,25	985,15	863,50	1.312,85	1.231,75	726,95	1.024,55	898,00
20,0	500	415,65	738,95	934,75	1.208,05	1.072,30	1.691,10	1.632,05	934,25	1.256,55	1.115,25
22,0	550	543,75	906,15	1.226,65	1.561,15	1.412,35	1.915,90	1.899,85	1.206,45	1.623,60	1.468,85
24,0	600	573,60	1.171,00	1.356,60	1.746,80	1.561,15	2.341,25	2.255,45	1.412,35	1.845,05	1.623,60
26,0	650	802,15	1.852,15	1.505,95	2.469,65	2.089,30	2.896,20	2.778,65	1.697,75	2.568,40	2.172,85
28,0	700	988,25	2.126,25	1.808,30	2.834,90	2.471,95	3.279,70	3.153,15	2.089,30	2.948,35	2.570,85
30,0	750	1.168,40	2.542,45	2.105,50	3.389,80	3.009,55	4.043,00	3.907,25	2.384,90	3.525,40	3.129,90
32,0	800	1.411,75	2.969,65	2.603,15	3.959,40	3.655,25	4.630,80	4.486,10	2.954,60	4.117,95	3.801,55
34,0	850	1.751,65	3.468,30	3.190,90	4.624,25	4.434,05	5.375,50	5.191,00	3.622,30	4.809,25	4.611,45
36,0	900	2.108,85	3.829,55	3.591,30	5.106,05	4.915,90	6.466,90	6.271,55	4.094,30	5.310,30	5.112,60
38,0		2.381,50	4.812,75	4.435,75	6.416,95	5.846,45	7.419,30	7.213,05	5.014,85	6.673,70	6.080,35
40,0	1000	2.745,70	5.230,50	4.902,20	6.973,85	6.403,40	7.998,15	7.781,05	5.565,95	7.252,80	6.659,60
42,0		3.078,60	5.702,00	5.735,55	7.602,65	7.032,25	9.201,80	8.974,00	6.187,10	7.906,80	7.313,50

Super Soft: 24 - 32 kg/m³ PU coated, color: yellow

Medium Density: 80 - 112 kg/m³ PU coated, color: blue



Hard: 128 - 160 kg/m³ PU coated, color: red

Other sizes and qualities on request.



Product group 960

Pipe bevelling tool 4 pipes

	Description	Art.-No.	€/pcs.
	Outside bevelling tool for plastic pipes OD 20, 25, 32, 40, 50, 63 mm	20301	37,70
	Outside bevelling tool for plastic pipes OD 75, 90, 110 mm	20306	76,50
	Inside bevelling tool OD 20-63 green	20315	37,70
	Spare blades for Art. No. 20301, 20306 and 20315, Pack of 10 pieces	20302	37,70

Cleaning strap 4 pipes

	Description	Art.-No.	€/pcs.
	Length 1 m for pipe 3" to 12"	20310	285,00
	Length 2 m for pipe 12" to 24"	20311	399,00

Uni-Key-Adapter

	Description	Art.-No.	€/pcs.
	Uni-Key-Adapter Standard 80 mm	20320	567,75
	Uni-Key-Adapter Mini 60 mm	20321	541,50

Shore D measuring tool

	Description	Art.-No.	€/pcs.
	Shore D measuring tool * with drag indicator for hardness test of Fibercoat Ultra and Pipecoat Watercure	20304	416,00*

*not discountable

Magnetic Manhole Cover Hammer and Accessories 4 pipes



Product group 960

	Description	Art.-No.	€/pcs.
	Magnetic manhole cover hammer Length 670 mm 130 kg magnetic holding force	20300	319,20
	Magnetic manhole cover hammer Length 670 mm 250 kg magnetic holding force	20312	555,00
	Magnetic cover lifter MD 400 400 kg magnetic holding force	20313	924,00
	Adapter lever for magnetic cover lifter MD 400	20314	810,00



Product group 880

Product	Description	Art.-No.	€/pcs.
 <p>Attention bulky freight Delivery ex works only</p>	<p>Pipe Stop Rail The length of the Rail: 4.013 mm Weight of the Rail: approx. 46,5 kg</p>	59050	1.048,15
	<p>Pipe Stop Block A Diameter range: Ø 200 - 406 mm Weight of the Block: approx. 5,5 kg</p>	59055	144,95
	<p>Pipe Stop Block B Diameter range: Ø 380 - 670 mm Weight of the Block: approx. 12,5 kg</p>	59056	220,55
	<p>Pipe Stop Block C Diameter range: Ø 660 - 1.590 mm Weight of the Block: ± 8,2 kg</p>	59057	164,45
	<p>Pipe Stop Block D Diameter range: Ø 1.030 - 2.575 mm Weight of the Block: ±. 16,2 kg</p>	59058	266,40
	<p>Pipe Stop End Cap Weight of the End Cap: approx. 1,1 kg</p>	59059	122,90
	<p>Pipe Stop Rail Connector Weight of the Connector: approx. 0,6 kg</p>	59065	73,80
	<p>Pipe Stop Connector Installation Tool Weight of the Installation Tool: approx. 0,4 kg</p>	59066	152,05
	<p>Pipe Stop Anti-Skid Sheet Weight of the Anti-Skid: approx. 1,4 kg/meter</p>	59068	19,95 €/m

Pipe storage system - Pipe Carrier Premium









Product group 880

Product	Type	Weight (kg)	Art.-No.	€/pcs.
	Pipe Carrier Premium 6 Base	11,2	59080	230,20
	Pipe Carrier Premium 6 Mid	12	59081	242,55
	Pipe Carrier Premium 5 Base	11,8	59082	230,20
	Pipe Carrier Premium 5 Mid	11,5	59083	242,55
	Pipe Carrier Premium 4 Base	11,2	59084	230,20
	Pipe Carrier Premium 4 Mid	12	59085	242,55
	Pipe Carrier Premium 3 Base	12,3	59086	258,15
	Pipe Carrier Premium 3 Mid	13,9	59087	286,45
	Pipe Carrier Premium 2 Base	15,6	59088	326,80
	Pipe Carrier Premium 2 Mid	18	59089	372,00

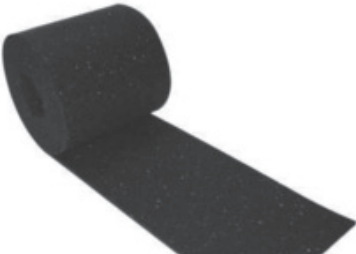

Product group 880

Product	Description	Art.-No.	€/pcs.
 <p>Attention bulky freight Delivery ex works only</p>	<p>System88 steel profile The square profile is available in the standard width of a - truck's trailer: 2.450 mm - train's trailer: 2.700 mm The weight of the profile is approx. 20 kg (truck) / 22kg (train)</p>	<p>59000 59001</p>	<p>644,00 644,00</p>
	<p>System88 Block A This block will be placed on the bottom-profile. Diameter range: Ø 219,1 - 558,8 mm. Weight of the Block: approx. 1-8 kg</p>	59005	105,95
	<p>System88 Block B for bottom-profile for Ø 406-945 mm</p>	59007	164,55
	<p>System88 Block C for bottom-profile for Ø 558-1422 mm</p>	59009	196,55
	<p>System88 Block D for bottom-profile for Ø 1422-2032 mm</p>	59010	332,75
	<p>System88 Block K This block will be placed on a mid-profile. Diameter range: Ø 219,1 - 558,8 mm. Weight of the Block: approx. 2,8 kg.</p>	59006	137,90
	<p>System88 Block L This block will be placed on a mid-profile. Diameter range: Ø 406,4 - 1.219,2 mm Weight of the Block: approx. 7,4 kg.</p>	59008	228,95
	<p>Locking pin for blocks This pin is used to secure the block on the rail. When the block and the rail align, a pin is placed through the aligned holes. Weight of the Locking pin: approx. 0,6 kg</p>	59015	15,60
	<p>Securing clip for Locking pin This is a safety attribute which will decrease the chances of the pin failing to secure the block on the rail. Weight of the clip: approx. 0,1 kg.</p>	59016	1,20
	<p>Anti-skid sheet (NOT used when working on trains) Anti-skid increases the friction between System88 and the load (0.3 → 0.6). Although it is not mandatory, 4 pipes strongly recommends using it. Weight of the anti-skid: approx. 1,4 kg/m.</p>		
	<p>2,50 metre 2,75 metre</p>	<p>59017 59018</p>	<p>53,10 53,10</p>



§ 1 Application

- (1) Our terms of sale apply only to companies.
- (2) Only our terms of sale apply. conflicting terms of the customer are not accepted.
- (3) Our terms of sale apply also for future deliveries to the customer.

§ 2 Price and payment

- (1) Our actual price list on the day of delivery is applicable. Our prices are EXW (ex works), unless otherwise agreed. All costs for packing and transport belong to the customer. We are allowed to pass on any increase for value-added tax, freight, duty, raw material, supplies and labor costs.
- (2) Our invoices are payable net within 30 days, for payment within 14 days we grant 2% cash discount. We charge interest of 8% above the relevant base interest rate for delayed payment, the assertion of further damages remain unaffected. Checks are only considered as payment after the check has been cashed.
- (3) Counterclaims are only accepted if they are undisputed or legally established.

§ 3 Offer and acceptance

- (1) Our offers are subject to change, unless explicit otherwise agreed.
- (2) Orders received are binding.
- (3) In case of online-orders the customer makes a binding offer by using the order button, with our order confirmation the contract becomes valid.

§ 4 Delivery

- (1) The given delivery time requires, that the customer fulfils all contractual duties in time, especially all technical details have to be clearly defined and all drawings require a qualified approval.
- (2) Place of delivery is our business location. The risk passes to the customer upon receipt by the carrier. In case the acceptance of the delivery is delayed, the risk passes to the customer when we are ready to deliver; in that case the customer bears the cost for storing and maintaining the goods.
- (3) Unless otherwise agreed, the times for delivery or performance are always approximated and refer to handing over the goods to the carrier.
- (4) Our obligation for delivery depends on receiving our own deliveries on time. Partial deliveries are allowed if the customer can use it. Our obligation is fulfilled, if and when the delivery is within generally admitted tolerances.

§ 5 Inability to pay our invoice

If and when the customer is late in payment by more than four weeks, we are allowed to rescind the contract or ask for securities in the amount of the outstanding receivables.

§ 6 Warranty

- (1) The customer shall assert claims due to defective goods, supplied by us, in writing without delay. If the defect of the goods was already predictable in the drawing, the customer can only assert claims if he informs us without delay in writing about the faulty drawing.
- (2) Our supply is correct, if it is within the relevant industry and quality standards and measurement limits.
- (3) It is the sole responsibility of the customer to check carefully the fitness of the goods for the intended use.
- (4) In case of defect goods we are entitled to eliminate the defect or supply replacement. If the rework or the replacement delivery fails, the customer has the right of conversion or withdrawal of the contract, as far as the law provides for.
- (5) The description of our goods does not cause any guarantee, this applies likewise for all information on our website.
- (6) The status of limitation for claims of defects is 12 month, except § 438 Abs. 2 Nr. 2 und § 634 a Abs. 1 BGB provide for longer periods.
- (7) No warranty is applicable, if the customer or a third party alters the goods without our approval.

§ 7 Reservation of title

- (1) We keep ownership of the goods until the complete payment has been received.
- (2) If and when the customer is late in payment, we are allowed to rescind the contract. We demand immediate information in case of intervention by third parties, any costs of third-party proceedings are borne by the customer.
- (3) The customer is allowed to sell the goods with or without further treatment; all claims which accrue from resale are assigned to us.
- (4) Any processing of the delivered goods is made on our behalf. In case our goods are processed with third-party material, we acquire shared ownership in the new product in relation of the used materials.

§ 8 Liability

- (1) Our liability for breach of contract in case of own gross fault is limited to the compensation for the typically foreseeable damage.
- (2) We are liable for any culpable breach of main contractual obligations and culpable injury to life, body and health.
- (3) Any further liability is excluded; compulsory liability by law remains unaffected.
- (4) Services which are provided for free are not part of our contractual duties and therefore exempt from any liability.

§ 9 Law and jurisdiction

Our contracts are subject to German law, the commercial UN-law is not applicable. Place of jurisdiction is our place of business, we reserve the right to take action against the purchaser at his place of business.

Version 01/2012



4 pipes GmbH • Sigmundstraße 182 • 90431 Nuremberg/Germany
Phone +49 (0)911 81006-0 • Fax +49 (0)911 81006-111
info@4pipes.de • www.4pipes.de



© 4 pipes GmbH 01/2024